

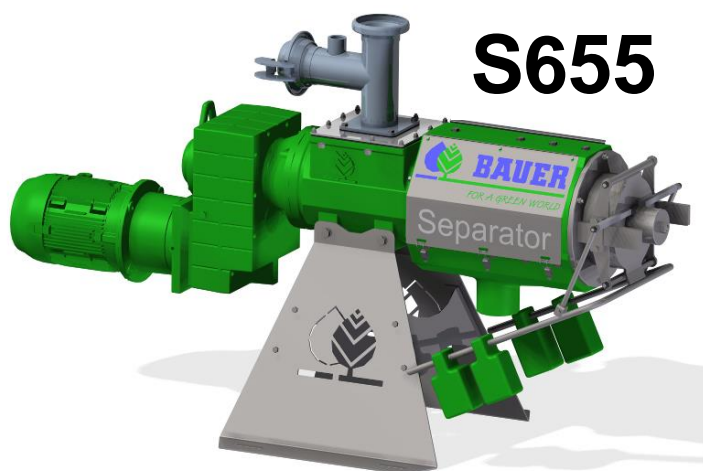

BAUER

FOR A GREEN WORLD

ORIGINAL OPERATING MANUAL FOR SEPARATORS



GB855

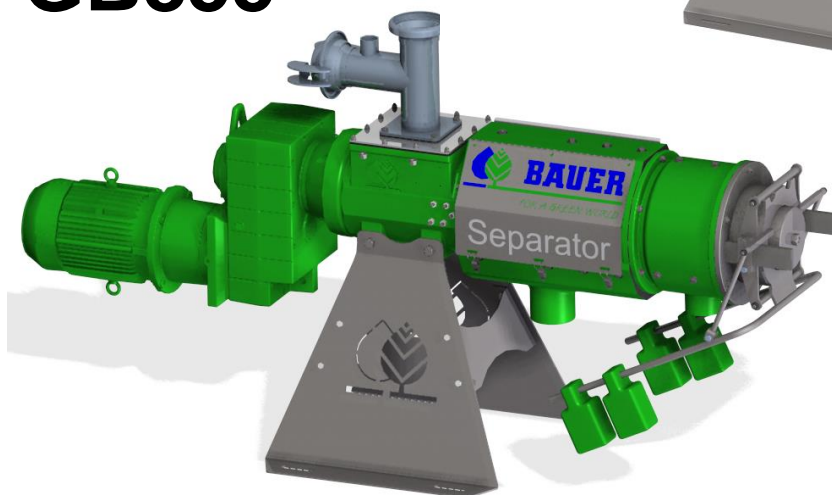

Thank you for buying a BAUER separator!

This **operating manual** is an important document that describes the operation and maintenance of the **BAUER SEPARATOR**.

All information contained in this manual is based on the latest product details available at the time of printing. If you need still more information, please ask your dealer or contact the **BAUER** company directly.

Please note that the content of this manual neither constitutes part of nor alters in any way any previous or existing agreement, promise or legal relationship. **BAUER**'s obligations are based solely on the respective purchase contract, which also contains the complete and only valid warranty agreement. Said contractual warranty is neither extended nor limited by the content of this manual.

The **BAUER SEPARATOR** is designed for safe and reliable operation provided it is operated in accordance with this operating manual.

You should therefore study this manual thoroughly before starting your **BAUER SEPARATOR**! Strictly observe all instructions pertaining to system handling, operation and service!

If these conditions are ensured, the **BAUER SEPARATOR** will operate to your complete satisfaction for many years to come.

The content of this operating manual is the intellectual property of the company **BAUER GesmbH** and/or its supplier companies. The available information may only be used in connection with the creation of specification-compliant documents in the course of an order from the **BAUER** company. Without express written permission from the **BAUER** company, no reproduction or sharing of this operating manual is permitted, even in excerpts.

The **BAUER** company reserves the right to make changes at any time without notice and without assuming any liability!

In the interests of a clearer presentation and due to the large number of possibilities, this operating manual does not contain all detailed information and, in particular, cannot address every conceivable operating and maintenance situation.

WARNING



Failure to follow this manual may cause personal injury or damage the equipment!

NOTE



This manual is to be considered an integral part of the **BAUER SEPARATOR**. Suppliers of both new and used systems are advised to put down in writing that they delivered the manual together with the system.

Please make this manual available to your staff. State the pump type and serial number of your **BAUER SEPARATOR** in all inquiries, correspondence, warranty problems or parts orders. You will find this information on the type plate riveted onto the screen housing of the separator.

We wish you great success with your BAUER SEPARATOR!

PRODUCT DETAILS

Type designation: Separator

Type number: S 655 ; S 855 ;

Serial number¹: _____

Dealer:

Name: _____

Address: _____

Tel. / fax: _____

Shipping date: _____

Producer of the machine:

Röhren- und Pumpenwerk **BAUER** Ges.m.b.H.
Kowaldstr. 2
A - 8570 Voitsberg
Tel.: +43 3142 200 - 0
Fax: +43 3142 200 -320 /-340
e-mail: sales@bauer-at.com
www.bauer-at.com

Owner or operator:

Name: _____

Address: _____

Tel. / Fax: _____

Note: Make a note of the type designation and serial number of your separator and its accessories. Include these numbers along with all contact with your dealer.

¹ It is very important to include with all guarantee claims and all correspondence related with this machine the entire serial number group, including all letters, both for the machine and for its relevant components. This point cannot be stressed enough.

TABLE OF CONTENTS

1	GENERAL SAFETY INSTRUCTIONS	4
1.1	Warnings and Symbols.....	4
1.2	Duty to Furnish Information	4
1.3	Product Liability.....	4
1.4	Qualified Operators	5
1.5	Intended Use	5
1.6	Unauthorized Modification and Manufacture of Replacement Parts	5
1.7	Disposal.....	5
2	GENERAL INSTRUCTIONS FOR SAFETY AND ACCIDENT PREVENTION.....	6
3	FUNCTION DESCRIPTION.....	9
4	SETUP OF THE SEPARATOR	10
4.1	Installation Diagram	10
4.2	Condition of the BAUER Separator upon Delivery	10
4.3	Required Tools	10
4.4	Features, Identification and Information	11
4.5	Type plates - Information Signs.....	12
4.5.1	<i>Information on the Separator Type Plate</i>	<i>12</i>
4.5.2	<i>Information Signs.....</i>	<i>12</i>
4.6	Separator Technical Data	12
4.7	Setup and Assembly.....	13
4.8	Complete System	14
4.8.1	<i>Standard Setup.....</i>	<i>15</i>
4.8.2	<i>Alternative Setup</i>	<i>15</i>
4.8.3	<i>Drainage Line</i>	<i>15</i>
5	ELECTRICAL CONNECTION.....	16
5.1	Setup and Operation of the Motor	17
5.2	Condensate Hole	17
5.3	Installation Without Switch Cabinet	17
6	PREPARATION FOR INITIAL STARTUP	18
7	INITIAL STARTUP	18
7.1	Configuration Instructions.....	18
7.2	Solid Cake Formation	19
7.3	Configuration to Stabilize the Solid Cake	20
7.3.1	<i>Cake Too Firm.....</i>	<i>20</i>
7.3.2	<i>Cake Too Soft</i>	<i>20</i>
7.4	Additional Instructions for Flawless Operation	21
8	WINTER OPERATION	21
9	TEST FOR SEPARATION CAPABILITY:.....	22
10	LIQUID CLEANING	23
11	IMPORTANT ASPECTS TO BE CONSIDERED DURING OPERATION.....	23
12	TAKING THE SEPARATOR OUT OF OPERATION	23

13	MAINTENANCE AND INSPECTION	24
13.1	Gearbox and Motor	24
13.1.1	Supply with Sealing Medium	24
13.1.2	Supplemental Seal	25
13.2	Inspection of the Screen and the Guide Rails	26
13.3	Inspecting and Reinstalling the Screen	28
13.4	Inspecting and Reinstalling the Auger	29
13.5	Evaluation Criteria for the Auger and Screen with Regard to Wear and Recoating	30
13.6	Summary of Maintenance and Inspection Intervals	31
14	PROBLEMS - TROUBLESHOOTING	32
14.1	Principles of a "Normal" Operating Condition	32
14.2	Troubleshooting	33
15	ACCESSORIES	36
15.1	Separator Control	36
15.1.1	Timing Relay for Forward and Reverse Running K9	37
15.1.2	Motor protection circuit breaker F4	38
15.1.3	Switchover time (pause between forward and reverse running) K7, K8	38
16	FILL LEVEL SENSOR	39
17	NOTES	40
18	CONFORMITY DECLARATION	41

1 GENERAL SAFETY INSTRUCTIONS

This operating manual contains important information that must be observed during setup, operation and maintenance. For this reason, it must always be read and observed very carefully by the installation technician as well as the qualified personnel. It must always be available at the usage location of the machine.

If the installation and maintenance are not carried out according to the operating manual, all warranty claims due to faults become void.

The customer is responsible for the proper setup of all equipment. Read the instructions before assembling or installing the machine. Promised performance characteristics of the machine and the add-on components as well as the fulfillment of any warranty claims are dependent on compliance with these instructions.



The CE mark applied by the manufacturer provides external verification of the machine's conformity with the provisions of the Machinery Directive and with other pertinent EC directives.

1.1 WARNINGS AND SYMBOLS

The following notes and warnings are used in this operating manual for especially important instructions:

DANGER 	Information, requirements or prohibitions to protect against serious injury or property damage.
--	--

WARNING 	Special information on preventing minor injuries or requirements and prohibitions to prevent damage to the machine.
---	--

NOTE 	Special instructions to simplify working with the machine or to aid in efficient use of the machine.
--	---

To prevent malfunctions that could directly or indirectly result in serious injuries or property damage, it is equally important to comply with any other instructions concerning transport, assembly, operation and maintenance as well as reference data (in the operating manual, the product documentation or on the equipment itself).

1.2 DUTY TO FURNISH INFORMATION

When passing the machine on to a new owner, the customer is obliged also to hand over the operating manual to the new owner. The recipient of the machine must be instructed with reference to the mentioned regulations.

Should you encounter difficulties in understanding this manual or other instructions, contact the respective dealer or the BAUER company for any necessary clarifications.

1.3 PRODUCT LIABILITY

According to the Product Liability Act, every farmer is an entrepreneur!

In accordance with Section 9 PHG (Product Liability Act), liability for damage to physical property caused by defective products is expressly excluded. This exclusion of liability also applies to parts not manufactured by BAUER itself but purchased from external suppliers.

1.4 QUALIFIED OPERATORS

These are persons who on behalf of their training, experience and instruction as well as their knowledge of relevant standards, rules, precautions to be taken for accident prevention and prevailing operating conditions have been authorized by the person in charge of system safety to perform the respective tasks required and in doing so are able to recognize and avoid potential hazards. The statutory minimum age for the operating and maintenance personnel must be observed. Among other things, knowledge of first aid procedures is also required.

1.5 INTENDED USE

- The BAUER separator is designed exclusively for solid-liquid separation in agricultural applications (inslurry tended use).
- Any use of the machine beyond this intended use is considered non-conforming. The manufacturer is not liable for damage resulting from such non-conforming use, the sole liability for damage from non-conforming use lies with the user.
- Intended use also includes compliance with manufacturer's operating, maintenance and service instructions.
- The BAUER separator may be used and operated only by persons who are familiar with the system and aware of the hazards involved.
- All relevant rules for accident prevention as well as any other generally accepted rules and regulations relating to safety, occupational medicine and traffic laws must be strictly observed.
- Unauthorized modifications to the machine release the manufacturer from liability for damage resulting from such modifications.

1.6 UNAUTHORIZED MODIFICATION AND MANUFACTURE OF REPLACEMENT PARTS

Modifications or alterations to the machine are only permitted after consultation with the manufacturer. Original replacement parts and authorized accessories from the manufacturer serve the interests of safety. The use of other parts voids the manufacturer's liability for any resulting consequences.

The replacement parts used must correspond to the technical requirements established by the manufacturer of the system. The replacement and wearing parts delivered with the machine or via subsequent orders satisfy this condition.

1.7 DISPOSAL

The machine must be disposed of according to the local disposal regulations.

The user must ensure safe and environmentally friendly disposal of operating materials and ancillary materials as well as replaced parts. Dispose of oil, grease, and filters in accordance with regulations!

2 GENERAL INSTRUCTIONS FOR SAFETY AND ACCIDENT PREVENTION



WARNING

Check the operational safety of the machine before every start !

- All regulations of public authorities that apply to the operation and maintenance of the system must be strictly observed.
- In addition to the operating manual, all generally applicable statutory and otherwise mandatory regulations on accident prevention and environmental protection must be separately prescribed and observed.
Such obligations may concern, for instance, the handling of hazardous substances, the provision and wearing of personal protective gear or traffic and road safety regulations.
- The operating manual should be extended with the instructions for taking into account special operating conditions, such as with regard to the work organization, work processes and the active personnel. The supervisory and reporting obligations of the operator must also be clearly regulated.
- To ensure your safety and the safety of your employees, every person who is responsible for operating the system must also be familiar with these obligations. It is too late for this when the system is already running!
- The personnel assigned to operating the plant must have read the operating manual and in particular the section "General Instructions for Safety and Accident Prevention" before starting work.
- Every person must be aware of the safety measures that must be complied with during work on electro-mechanical components and machines.
- Only trained personnel may enter the hazard zone of the machine.
- Only trained personnel may be assigned to work with the machine. The respective competencies of the personnel for the operation, setup, maintaining and repair of the machine must be clearly defined. It must also be ensured that only appropriately authorized personnel work on the system.
- Personnel who are being trained, taught, instructed or are participating in a general training program may only work on the system under the constant supervision of a person experienced in operation of the system.
- The safety- and risk-conscious work by the personnel in compliance with the operating manual must be checked at least at certain intervals.
- The personnel assigned to operate the machine may not have:
 - ⇒ Exposed long hair
 - ⇒ Loose clothing
 - ⇒ Jewelry, including rings and drop earrings
 Such items could get stuck and/or drawn into the machine, resulting in possible injuries.
- The operating personnel of the system must be familiarized with the fire alarm and fire-fighting options.
- The wearing of personal protective gear such as hearing protection, safety glasses, safety shoes, etc. during operation of the system must be required by means of rules or regulations.
- All safety information and warnings present on the machine must be pointed out, and these must be kept on the system in a clearly visible and legible condition.
- In event of safety-relevant changes to the system or its operating behavior, the system must be immediately shut down and the fault must be reported to the competent person or office.
- Replace pipelines and hoses in the specified or otherwise reasonable intervals, even if no operationally relevant defect is discernible.
- Intervals that are required or specified in the operating manual for regular daily, weekly and monthly inspections and tests must be complied with. Appropriate tools and equipment must be kept available for the performance of such work.
- Any potentially unsafe work on the machine must be avoided. The system may only be used in accordance with its intended use. All necessary measures must be taken to ensure that the system is only operated in a safe and fully functional condition.
- The system may only be started up if all protective and safety-related features are fully functional. This includes the fact that all removable protective features, **EMERGENCY STOP** buttons and covers must be present and functional.



- The system must be inspected for externally identifiable defects before it is started up each time. Any changes that occur, including changes to the operating behavior and functional disruptions, must be immediately reported to the competent party. The system must be immediately shut down and secured.
- Procedures for switching the machine on and off as well as inspection of the control indicators must be carried out as described in the operating manual.
- Before switching on or starting up the machine, it must be ensured that no one will be endangered by the starting up of the machine.
- The correct functioning of the controller must be checked before the start of work. Before startup, all tools and assembly aids must be stored safely to prevent accidents.
- The maintenance, configuration and inspection activities and deadlines specified in the operating manual must be complied with. The specified deadlines are maximum deadlines and may not be exceeded. Such work as well as the replacement of components may only be performed by qualified personnel.
- During transport of the separator, measures must be taken to ensure sufficient securing of the transport area.
- The required switch-on and switch-off procedures according to the operating manual and the instructions for maintenance work must be observed during all work involving the operation, production adaptation, conversion or configuration of the system and its safety-related features as well as all work involving inspection, maintenance and repair.
- The operating personnel must be informed of special work, repair work or conversion work in a timely fashion prior to starting the work. A supervisor must always be appointed during the performance of such work.
- The work area must be blocked off and secured by a wide margin during such work, if necessary. Unauthorized persons must be prevented from entering.
- As a rule, maintenance and cleaning work as well as repairs of malfunctions may take place only with the drive switched off and the motor at rest (switch off and lock the main switch or disconnect the supply of electricity).
- Watch out for the unexpected starting of the system.
- It must be noted that a pressed EMERGENCY OFF button does not provide any protection against unauthorized starting of the machine.
- During disassembly and assembly, large individual parts and entire assemblies must be carefully fastened and secured to lifting equipment. Only suitable lifting equipment and load handling devices with sufficient carrying capacity and no technical operating defects may be used. Standing or working under suspended loads is not permitted. Grips, steps, railings, landings, platforms and ladders must be cleaned of oil, dirt, snow and ice before all activity on the system.
- If the BAUER separator is installed on an elevated platform, this must be equipped with a railing. The platform should be sufficiently dimensioned to allow maintenance and service work.
- Any openings in the platform must be sufficiently secured against tripping or falling through.
- Access stairs must be equipped with hand rails in accordance with applicable regulations.
- If access stairs cannot be used due to tight space conditions, permanently mounted ladders with back protection must be used.
- Securing of personnel with suitable supporting elements is required during all maintenance work on an elevated system.
- During assembly work above head height, climbing aids and work platforms intended for such work or specially adapted for purposes of safety must be used. Never use system components as climbing aids. The system and, in particular, connections and bolt connections must be cleaned of oil, grease or care agents prior to the start of maintenance or repair work. No aggressive cleaning agents may be used. Only fiber-free cleaning cloths may be used.
- Before cleaning the system with water, steam, high-pressure cleaners or other cleaning aids, cover / tape over all openings into which no water, steam or cleaning agents may enter for safety and/or functional reasons. Electric motors and electronic switch cabinets are at particular risk. After cleaning, the applied covers / tape must be completely removed again.
- Wear appropriate protective gear to protect against flying particles while cleaning with compressed air or steam jets.
- After cleaning, all gear oil and media lines as well as all electrical connections must be inspected for leaks, loosened connections, abrasions and damage. Identified defects must be corrected immediately.

- The bolt connections loosened during maintenance and repair work must be tightened again. Observe the required tightening torques.
- If it is necessary to remove safety features during maintenance, setup or repairing, the safety equipment must be re-installed and inspected immediately after completion of the work.
- Do not start the machine unless all guards and safety devices are mounted completely and in proper working position!
- Protective caps and covers may not be removed.
- The stickers affixed to the device with safety and warning signs provide important instructions for safe operation; following these instructions is intended to keep you safe! These may not be removed.
- Check the proper seat of nuts and bolts regularly, and tighten them, if needed!
- When replacing operating elements with blades, use a suitable tool and wear gloves.
- The system is electrically operated. Take special care when performing work in the area of electrically operated system components.
- Work on electrical and electronic components of the system may only be performed by a trained electrician or otherwise appropriately trained personnel under the guidance and supervision of a trained electrician in accordance with the applicable electrical and electronic regulations.
- With regard to an ATEX 95 zone 22 certification, see the special remarks.
- Never touch rotating or moving parts of the machines with hands or feet.
- Never reach with hands, tools or other parts over the inflow or hopper in the area of the auger while the machine is running.
- In handling slurry, always remember that the gases produced by the slurry are highly toxic and explosive in combination with oxygen. Open flame, light checks, spark creation and smoking are therefore prohibited!
- When using the retention or alternating retention method, special care must be taken in the area of the opened sliding gates to the pre-pool before the main tank or to cross channels due to the formation of gases. In addition, special care is required at stirring and withdrawal points while the stirring machines or pumps are active!
- Keep the machine clean to decrease the risk of fire!
- Always ensure sufficient ventilation when working with slurry!
- When working with biologically active materials in connection with the BAUER separator or connected components, the decomposition of these materials can lead to the production of life-threatening gases, especially in enclosed spaces. Always ensure sufficient supply and exhaust ventilation and/or appropriate protective clothing before entering such areas.

DANGER 	<p>In addition to the mechanical dangers of moving parts or parts under pressure, the operation of slurry handling machines also poses risks in connection with gases produced by liquid manure. These gases (carbon dioxide CO₂, ammonia NH₃, hydrogen sulfide H₂S, methane CH₄) can result in poisoning as well as explosions.</p> <p>Especially when operating mixers, stirring machines, recirculation systems, pipe nozzles and slurry aeration systems, care must be taken that no gases can flow into the stall from exterior tanks or containers (install siphons or sliders).</p> <p>Sufficient forced ventilation of the stall area must be ensured while handling slurry in the stall area.</p>
--	---

3 FUNCTION DESCRIPTION

The BAUER separator serves for separating pumpable slurry (solid-liquid mixtures with relatively low solid matter content and no foreign bodies such as metal parts, stones, wood or rags) into solid and liquid (thin slurry) fractions. As a compact device, it combines the functions of **two** separators, specifically the functions of a screen and a press.

The BAUER separator is designed for sustained operation outdoors. It operates unimpaired in a temperature range of 0-40 °C; in event of freezing temperatures, it must be ensured that the separator is cleaned completely each time before being taken out of operation. Conditions of high humidity (e.g. locations near to the coast) and extreme sunlight as well as installation in areas at risk to explosion (gas: max. zone 2 (G)) require special designs for the gears and motors. Consult the manufacturer concerning such designs.

When selecting the feed pump and the overflow line, make certain that the separator is operated under no pressure.

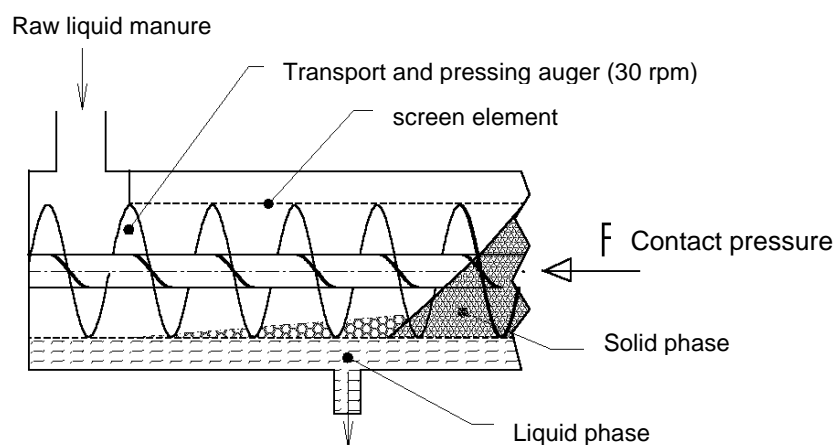

Fig. 3-1 Function description

In the inflow area, the mixture is drained of water via gravity inside the screen. The interior auger transports the pre-drained material horizontally toward the solid outlet. Along the last section of the transport path, the auger presses out additional liquid, which escapes the separator through the screen as thin slurry. The required contact pressure is applied to the escaping solid by a system consisting of a cap loaded by a weighted lever.

The solid-liquid separation depends entirely on the type of slurry. For example, the extent to which water can be drained differs greatly between dairy cattle, beef cattle and pig slurry. Users of the BAUER separator have many options for optimizing the separating result.

- The throughput can be increased by selecting a larger screen gap width.
- The residual moisture in the separated solid decreases as the contact pressure of the output regulator is increased.
- The solid matter content in the separated liquid can be reduced with a smaller screen gap width.
- The degree of solid separation is improved by smaller screen gap widths.

More information about the configuration options can be found in section 7 “Initial Startup”.

4 SETUP OF THE SEPARATOR

4.1 INSTALLATION DIAGRAM

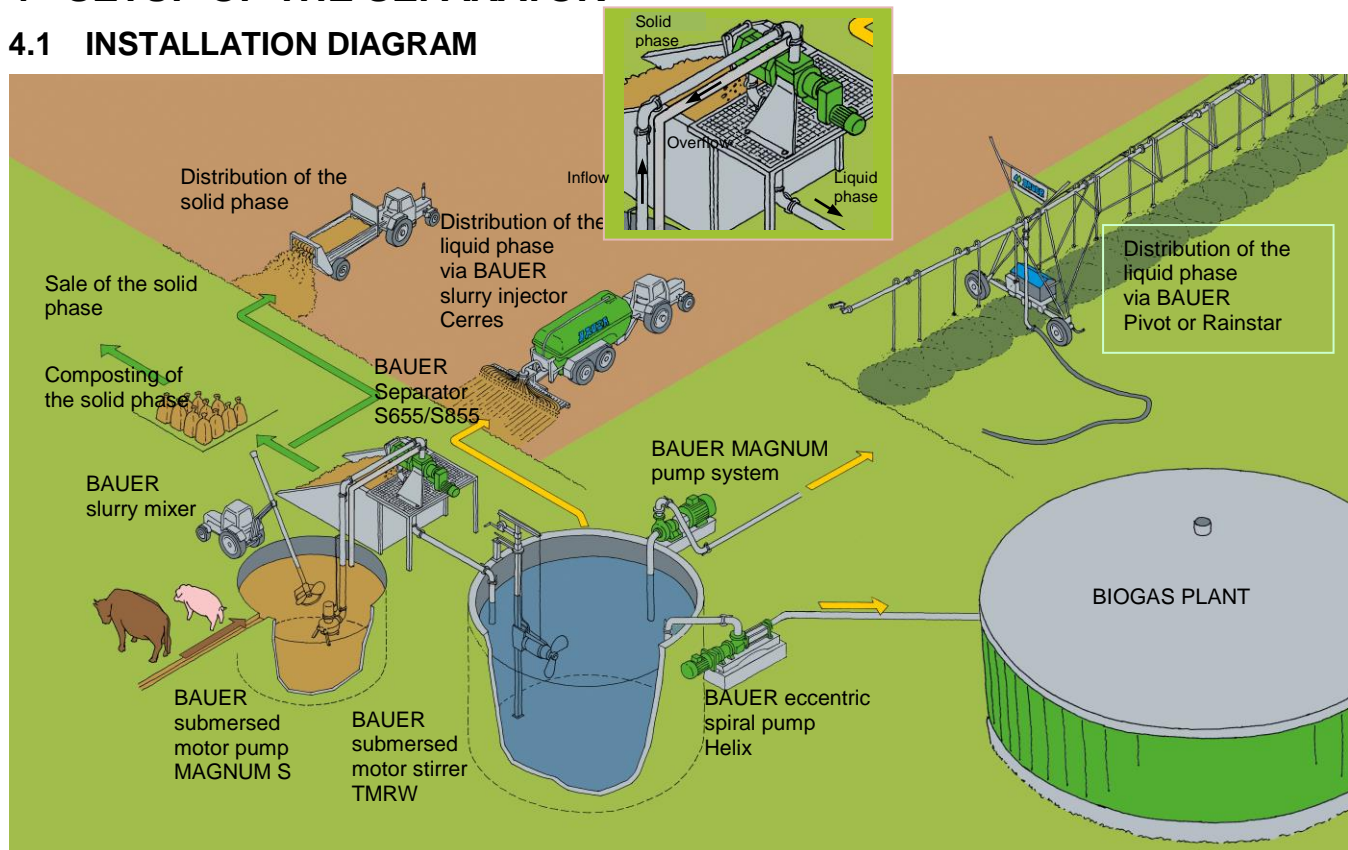

Fig. 4-1 Installation diagram

4.2 CONDITION OF THE BAUER SEPARATOR UPON DELIVERY

The BAUER separator was developed by the company BAUER GesmbH. The separator is delivered as a unit, including installed electric motor, on a pallet. The inflow T-piece and the ventilation pipe are enclosed separately for easier transport and must be installed before the initial startup.

You must connect the geared motor of the separator to the power supply of the optionally available switch cabinet and connect this to the electricity supply. It is recommended that the corresponding electrical control for the separator or for the separator and the Bauer submersed motor pump be purchased from BAUER since it will be already adapted to the corresponding drive motors.

Connecting the supplied hoses, if included, to the inflow and discharge connections of the machine completes the installation of the BAUER separator.

DANGER



Work on electrical and electronic components of the system may only be performed by a trained electrician or otherwise appropriately trained personnel under the guidance and supervision of a trained electrician in accordance with the applicable electrical and electronic regulations.

4.3 REQUIRED TOOLS

Special tools are not required for setting up the separator.

Standard tools for assembly and electrical tools are required for assembly, setup and disassembly.

The customer must check based on the dimensions and weight of the separator whether the available lifting equipment (forklift, tractor with front loader, crane with corresponding belts or chains) is sufficient for setting up the separator.

4.4 FEATURES, IDENTIFICATION AND INFORMATION

To make it easier for you to familiarize yourself with your new BAUER separator, Fig. 4-2 shows you a longitudinal section of the internal machine design.

We assist every customer in optimally selecting the right main separator components for the specific application before it is purchased, manufactured, assembled and shipped.

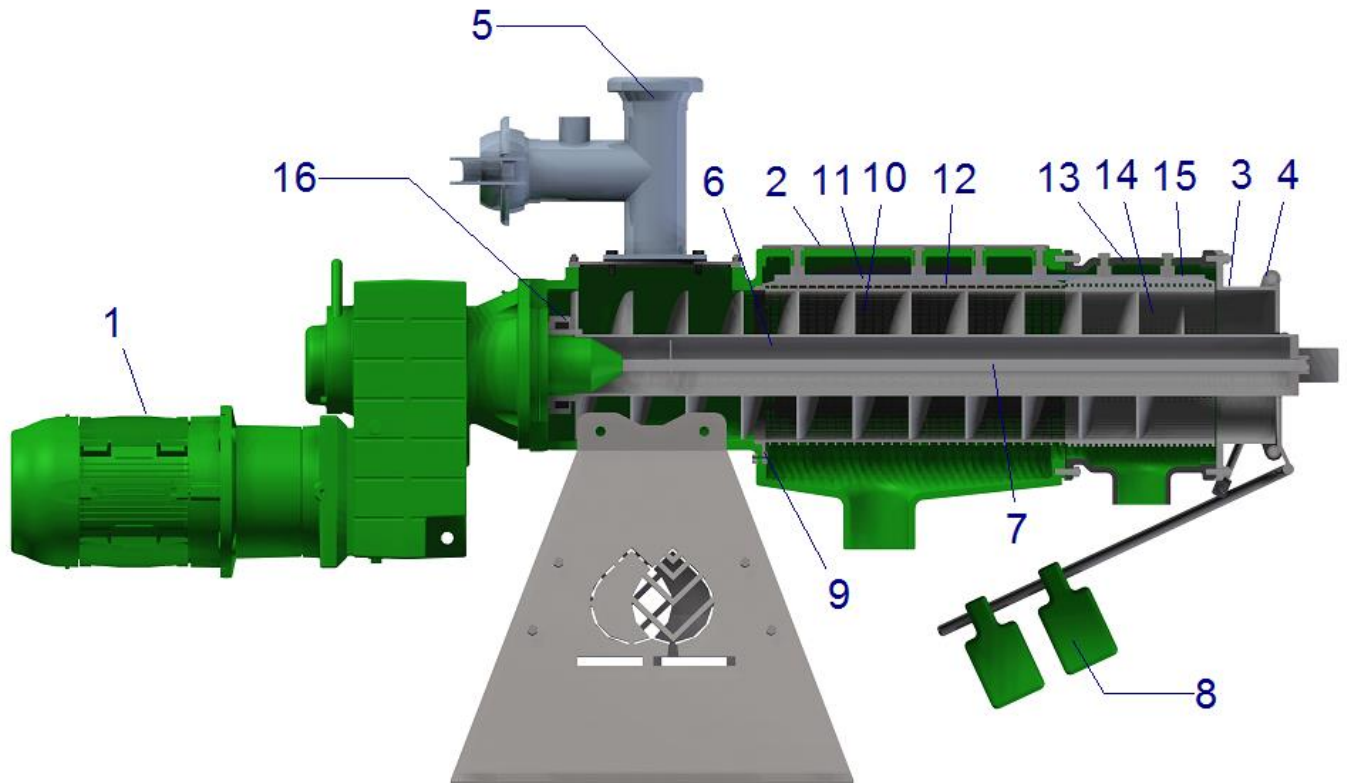

Item	Part	Item	Part
1	Geared motor	9	Housing protection ring
2	Screen housing	10	Screen 520
3	Mouth piece	11	Wearing profile 520
4	Output regulator with rod	12	Screen guide rails
5	Inflow element	13	Housing extension (only for S855)
6	Auger	14	Screen 260 (only for S855)
7	Auger bolt	15	Wearing profile 260 (only for S855)
8	Weights	16	Supplemental seal

Fig. 4-2 Main components

The precise article numbers of the wearing parts and the organization of the main components can be found in the replacement parts list.

4.5 TYPE PLATES - INFORMATION SIGNS

When you contact your dealer or communicate directly with BAUER GesmbH about wearing parts or for technical support for your separator, you will be asked for your serial number and machine number in order to ensure faster and more effective assistance.

The type, year of manufacture and serial number of the separator is indicated on the type plate riveted to the screen housing near the inflow. Another type plate is located on the geared motor. Associated details can be found in the enclosed geared motor documentation.



4.5.1 Information on the Separator Type Plate

The BAUER separator type plate contains the following information:

- Separator type: S655 or S855
- Screen used: e.g. 0.5 mm or 1.0 mm
- Serial number: e.g. X13N2389 (X is a fixed letter, 13 is a year, N is a fixed letter, 2389 is a 4-digit counter)

4.5.2 Information Signs

The following information signs are located on the BAUER separator:

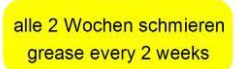
- Red arrow on the mouth piece; indicates the correct rotation direction of the auger shaft 
- Yellow text field on the mouth piece; warns of a turning part 
- Yellow warning symbols on the housing shell; indicate that turning parts should not be touched 
- Yellow text field on the geared motor; indicates the lubrication interval for the sealing grease 

Any damaged signs must be replaced. These can be ordered from your dealer.

4.6 SEPARATOR TECHNICAL DATA

Part name	Data	Material
Auger, auger shaft	Auger with special surface hardening	Steel, stainless
screen	Available gap widths 0.25 / 0.35 / 0.5 / 0.75 / 1.0 mm	Steel, stainless
Bearing housing		Gray cast iron, painted
Separator housing		Gray cast iron, painted
Inflow, overflow	BAUER T-piece HK 108,	Steel, galvanized
Bottom discharge connection S655	Pipe connection DN125	Integrated into separator housing
Bottom discharge connection S855	Pipe connection DN125 Pipe connection DN100	Integrated into separator housing Integrated into housing extension
Motor	5.5 kW, 50 Hz, 400 V, IP55, F 7.5 kW, 50 Hz, 400 V, IP55, F	For S655 /S855 For S855 HD
Underframe		Steel, stainless
Gearbox	Cylindrical gearing 28.2 rpm (50 Hz) Oil quantity and type – see type plate on gearbox	Gray cast iron

4.7 SETUP AND ASSEMBLY

The basic dimensions of the BAUER separator for determining the dimensions of the setup location are shown in Fig. 4-3.

The Separator S655 has a dead weight of approx. 600 kg and the Separator S855 of approx. 650 kg.

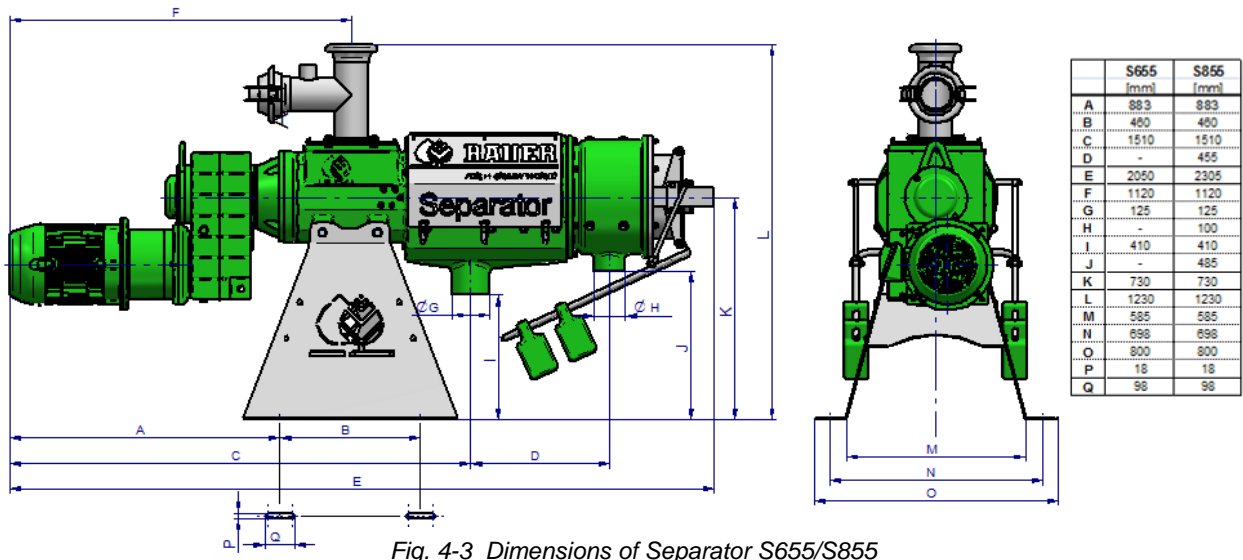

Fig. 4-3 Dimensions of Separator S655/S855

Fig. 4-4 illustrates a suggestion for determining the size of the separator setup location.

It is very important that a clearance of at least 1500 mm or more is ensured in front of the mouth piece of the separator. This clearance is required to remove the auger and the screen for maintenance. It must be possible to remove the auger and the screen for regular inspections.

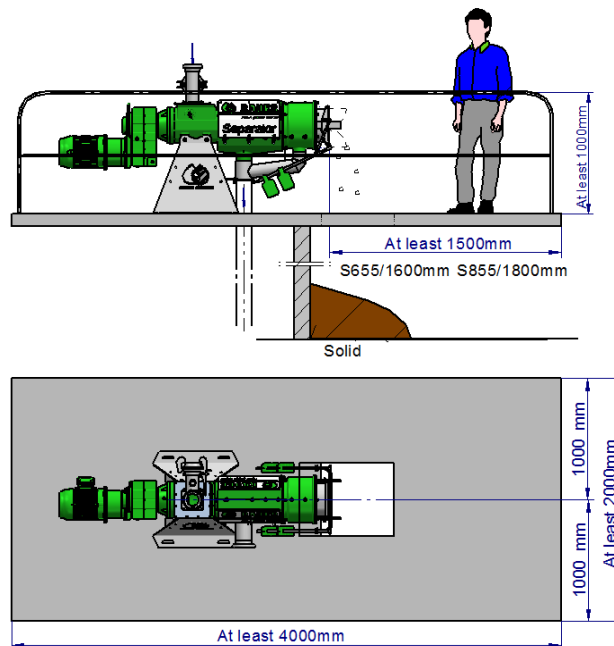

Fig. 4-4 Size of the setup location

- Width of the setup area: No less than 2000 mm
- Length of the setup area: No less than 4000 mm
- The surrounding clearance around the separator should be at least 1 m.
- Handrail height of the setup area: No less than 1000 mm

Make sure that the mouth piece and the functioning of the separator can be clearly seen from the switch cabinet. (It must be possible to watch the solid cake and its discharge speed.)

4.8 COMPLETE SYSTEM

The complete system of the press screw separator also includes the material supply and discharge handling.

The incoming material can be delivered by pump or from an elevated tank by means of gravity. Because the pump delivery rate cannot be precisely determined, an overflow is absolutely required in order to protect the separator from an overload.

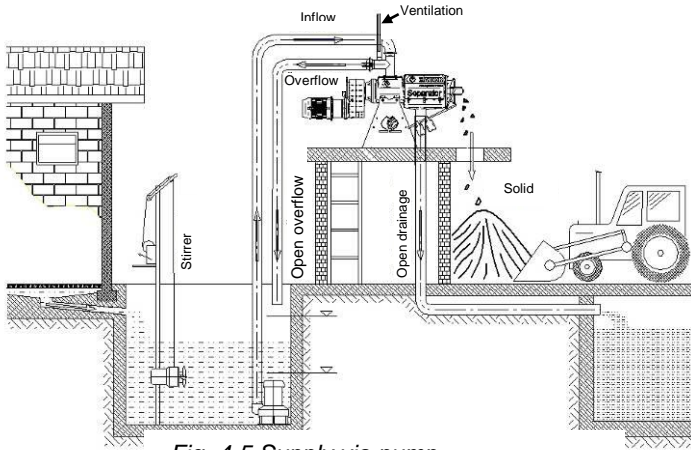

Fig. 4-5 Supply via pump

The pump should be designed to slightly exceed the capacity of the separator, but the pressure on the separator should not exceed **2 m water column [0.2 bar]**. A higher pressure would damage the seal in the separator.

In order to obtain a homogeneous mixture of solid and liquid, a stirring machine is required when supplying the slurry via a pump or from an elevated tank.

It is very important that the supply of material to the separator is always controlled by the switch cabinet.

The correct selection of the pump, the stirring machine and the supply and disposal lines is critically important.

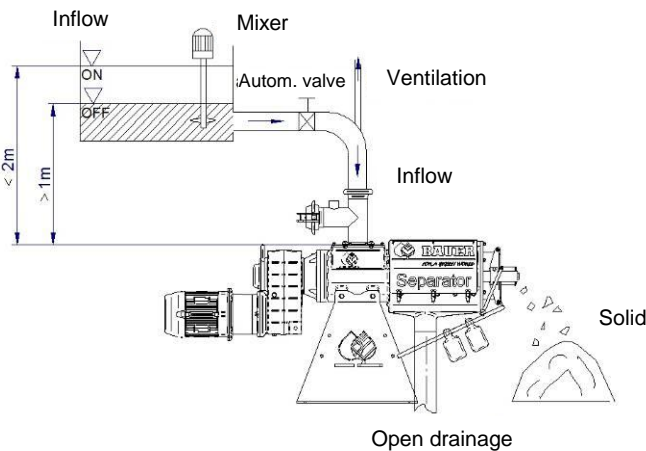

Fig. 4-6 Supply via gravity from an elevated tank

When supplying the press / auger separator from an elevated tank by means of gravity, a flow regulator may be required in some circumstances to limit the pressure on the separator. In this case, an overflow is not required.

The effluent should be disposed of via an open (and thereby ventilated) drain channel or collected in a drainage pit and then pumped out in order to avoid generating a suction effect on the separator. The ventilation is required because otherwise particles are drawn into the screen gap and remain stuck there, blocking the open screen surface and impairing the function of the separator.

The separated solid can be piled up and transported away as needed, brought away on a conveyor belt or disposed of by container or truck.

The supply line available with the BAUER separator as an accessory is a reinforced yet flexible tube. This reinforced tube is resistant to negative pressure. Ventilation openings can be added to the inflow line through the connection of a breather pipe to the T-piece. The ventilation is required for a pump with a very high pump capacity since the high flow speed in the overflow line would otherwise produce a siphon effect that would limit the supply to the separator and impair the separation process.



NOTE

The separator must be set up so that the solid can be freely discharged. There must be a corresponding height difference between the solid discharge point and the ground. The volume of the cone of discharged material can be determined based on the setup height.

The overflow line for the raw slurry as well as the drainage line of the separated slurry should drain without pressure into the corresponding storage tanks.

The overflow line should be run without a “siphon” in order to avoid a lifting effect and to ensure good separator throughput (see also section 14 “Problems - Troubleshooting”).

Avoid winding, dipping and twisting of the pipeline and use tubing that is resistant to negative pressure.

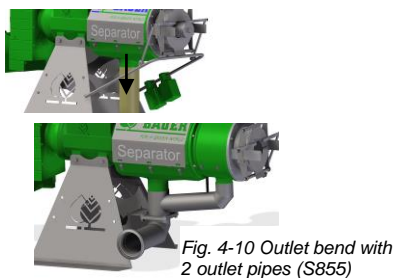
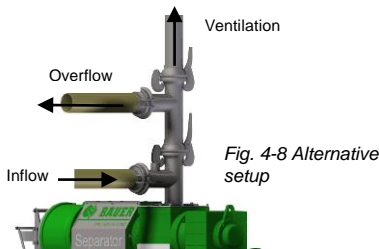
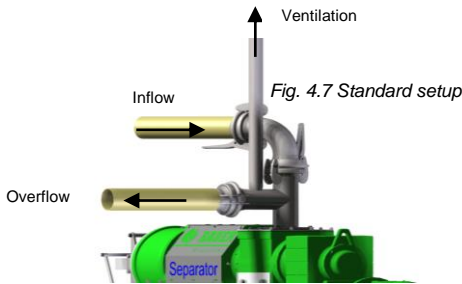

4.8.1 Standard Setup

- The T-piece is situated vertically on the inflow flange (top of separator housing).
- The supply line is connected to the top of the T-piece. This requires a BAUER coupling of dimension HK108. Transition elements for hose lines as well as bends are available as accessories.
- The overflow line is connected to the BAUER ball HK108 on the side of the T-piece.
- The breather pipe should be attached to the overflow line on the T-piece. This prevents the buildup of negative pressure in the separator if the medium creates suction in the return line.
- The breather pipe should extend approximately 1.5 m above the inflow line or overflow line. Connection: 1 ½" external thread.

4.8.2 Alternative Setup

- The T-piece is situated vertically on the inflow flange (top of separator housing).
- The supply line is connected to the BAUER ball HK108 on the side of the T-piece.
- The overflow line is connected to the side of an additional T-piece.
- The breather tube is connected to the top of the additional T-piece.

4.8.3 Drainage Line

- The drainage line is connected to the outlet tube DN125 on the bottom of the separator housing.
- An optionally available outlet bend is used to merge the two outlet pipes of the separator housing and the housing extension on the Separator S855 into one drainage line.

NOTE



If no Bauer pump is installed, the pump for supplying the separator should have a pump rate of at least 35 m³/h (50 m³/h for the S855) since the capacity of the separator otherwise cannot be fully utilized. To keep pressure losses due to pipe friction low, the pipes should have a diameter of at least 100 mm (4").

5 ELECTRICAL CONNECTION

The electric motor is equipped with a terminal strip. Like all electrical connections, the external motor control must be connected properly by a qualified electrician.

DANGER 	Work on electrical and electronic components of the system may only be performed by a trained electrician or otherwise appropriately trained personnel under the guidance and supervision of a trained electrician in accordance with the applicable electrical and electronic regulations.
--	--

WARNING 	Fuses do not protect the motor from overloads; they only protect the electrical supply lines or switching systems from damage in event of a short-circuit.
---	---

The electric motor must always be protected with a motor protection circuit breaker that must be set to the rated current shown on the type plate depending on the motor wiring. Only motor protection circuit breakers certified according to the following standards may be used: IEC, UL, CSA.

WARNING 	Set the motor protection circuit breaker to the correct value, never above the max. rated current according to the type plate.
---	---

It is recommended that the corresponding electrical control for the separator or for the separator and the submersed motor pump be purchased from BAUER since it will be already adapted to the corresponding drive motors.

WARNING 	Ensure the correct rotation direction of the auger shaft when making the electrical connection!
---	--

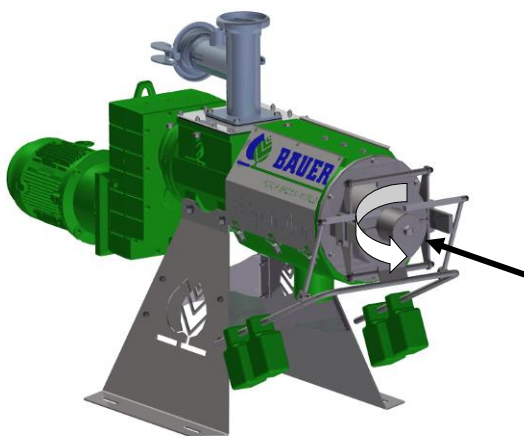

Fig. 5-1 Rotation direction of the auger

In forward motion, the auger shaft turns counterclockwise (as viewed from the output regulator toward the geared motor).

Viewing direction

If this is not the case, two of the current-carrying conductors at the geared motor connection or in the switch cabinet must be swapped.

5.1 SETUP AND OPERATION OF THE MOTOR

The motors in the standard design are suitable for operation up to a maximum ambient temperature of +40 °C (104 °F) as well as an elevation of up to 1000 m above sea level.

Conditions of high humidity (e.g. locations near to the coast) and extreme sunlight as well as installation in areas at risk to explosion (gas: max. zone 2 (G)) require special designs for the gears and motors. Consult the manufacturer concerning such designs.

The motors must be set up to allow unimpeded inflow of fresh air and dispersal of warm air. Removal of the fan blade and the fan housing or enclosing the motor in a housing are prohibited since the supply of cooling air would be reduced in both cases. This would cause the motor to overheat.

For use of an original BAUER control, see section 15 Accessories.

DANGER 	<p>Before making changes or inspecting the motor or switch cabinet, the machine must be disconnected on all sides and all poles and secured against reactivation!</p> <p>Always keep the switch cabinet closed!</p>
--	---

DANGER 	<p>It must be noted that a pressed EMERGENCY OFF button does not provide any protection against unauthorized starting of the machine.</p>
--	--

5.2 CONDENSATE HOLE

We recommend a condensate hole on motors that are subjected to high temperature fluctuations or extreme climatic conditions.

DANGER 	<p>A motor protection circuit breaker or a protective device with overload relay must always be installed to protect the motor winding (for the explosion-protected separator design, suitable motor protection must be selected). Fuses do not protect the motor from overloads; they only protect the electrical supply lines or switching systems from damage in event of a short-circuit.</p>
--	---

5.3 INSTALLATION WITHOUT SWITCH CABINET

If the BAUER separator was delivered or ordered without a switch cabinet, a few basic rules must be followed in controlling the separator; otherwise, the warranty is void:

- The motor must be equipped with electrical protection to prevent impermissible current loads exceeding the rated current on the type plate.
- Operating the separator without an inflow of material must be prevented by means of electrical control since dry running would otherwise result in increased wear on the screen and auger, which would significantly reduce their service lives. For this reason, the separator should be started up along with the start of the medium supply and stopped between 1 to 2 minutes after the medium supply is stopped.

6 PREPARATION FOR INITIAL STARTUP

Before beginning the startup process, check the following measures:

1. The separator must be firmly anchored to the ground.
2. Make sure that the mouth piece and the functioning of the separator can be seen clearly from the switch cabinet [it must be possible to watch the solid cake and its discharge speed].
3. Check the rotation direction of the auger. As viewed from the mouth piece, the auger must turn counterclockwise [if this is not the case, two phases must be swapped in the case of a 3-phase power supply].
4. If the material is supplied by a pump, the rotation direction of the pump must also be checked and corrected, if necessary.
5. A starter cake of solid material must be inserted for the startup, see section 7 Initial Startup.
6. Supply of sealing medium, see also section 13.1.1. When using grease as the sealing medium, 3 to 5 cm³ of grease must be introduced via the lubricating nipple [see Fig. 13-1] before initial startup in order to fill the labyrinth seal.
7. Check the oil level in the gearbox and top up, if necessary; properly dispose of old oil.
8. Check: The supply line between the pump and the separator is connected and sealed; the overflow line is connected and sealed; open discharge into the storage container; line for drainage of the separated slurry connected and sealed; open discharge into storage container.
9. Motor protection circuit breaker set to required rated current; after switching on, verify the correct rotation direction; note the arrow on the mouth piece; switch off the motor again.
10. Remove the weights (minimum closing force).

WARNING



It must be ensured that no large foreign bodies such as metal parts, stones, wood pieces or rags enter into the separator; such objects would otherwise overload the screen and the auger in particular. It should also be noted that abrasive media (e.g. high sand content) will reduce the service life of the components.

WARNING



The filling components must be connected such as to prevent injuries and to comply with the statutory regulations and safeguards.

7 INITIAL STARTUP

NOTE



In order to achieve good separating results, it is necessary to mix the pumped medium well before separating.

7.1 CONFIGURATION INSTRUCTIONS



Two weight arms and weights are available to stabilize the solid cake and to adjust the dry matter content. These weights should be affixed as necessary.

Fig. 7-1 Weight arms and weights

NOTE 	<p>The reaction time before each setting change takes several minutes, meaning that the effect of any change can only be determined after this time.</p> <p>For this reason, always allow enough time after making a change and only make changes in small steps!</p>
--	--

NOTE 	<p>Before the initial startup and after prolonged downtime, the separator should be flooded before switching it on by starting the pump briefly in order to prevent possible damage from dry running.</p>
--	---

7.2 SOLID CAKE FORMATION



Fig. 7-2 Discharge flaps

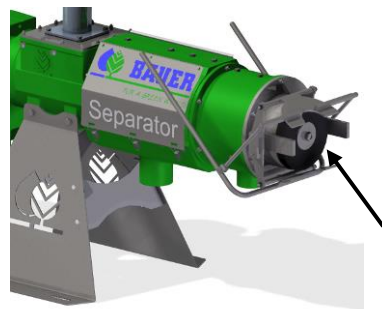

Fig. 7-3 Cake formation aid

If no solid cake is present in the discharge area, it must be ensured that the discharge flaps rest fully against the mouthpiece. After switching on the separator, start the pump only briefly - for about 1 to 2 seconds, just long enough for the supply line and separator to be filled. Then wait until liquid phase no longer runs out and repeat the process.

Depending on the pumped medium, a solid cake will begin to form after about 5 repetitions and push the cap away from the mouthpiece.

Alternatively an artificial cake can be created.

To do this, place a **cake formation aid** made of foam rubber that can be purchased as an option from BAUER behind the flaps or firmly pack by hand some other fibrous material such as hay, straw, silage, etc. behind the flaps. This starter cake is replaced as the separation process continues by a newly formed solid cake made of the separated medium, pressing out the starter cake. A starter cake should be employed when the solid cake has been removed from the machine for cleaning, inspection or maintenance purposes. If the machine is not operated for a prolonged period of time such that the cake has either hardened, frozen or become very soft, a starter cake is also required to restart the separator.

To create a starter cake of paper or similar material, check before beginning work that the **switch cabinet is disconnected from the electrical supply** and is not energized.

Then do as follows:

1. Remove the 4 weights from the arms of the output regulator in order to open the regulator flaps, then secure the flaps.
2. Insert the starter cake in the form of the cake formation aid made of foam rubber.
3. Or insert a starter cake of damp paper or similar material into the mouthpiece of the separator up to the ends of the auger blade.
4. To be certain that the cake forms a sufficient seal against the liquid, this should be evenly compressed with a piece of round wood, for example.
5. Place one weight in each middle position on the output regulator arms. The pressure flaps of the output regulator must rest against the starter cake such that pressure is applied to the cake when the separator is started up. As a suitable solid cake is formed, the output regulator arms will slowly move upwards

The pump can then be switched on without pauses.

Depending on the dry matter content (DM content) of the input medium, the solid cake will either already have the correct consistency with the initial setting of the weights or it will be either too soft or too firm.

After formation of a cake and roughly 20 cm of DM throughput, the base settings should be corrected again before the pump is set to continuous operation since the cake will otherwise “shoot out” if it is too soft or clog the separator if it is too hard.

As a rule of thumb for a stable cake consistency, note the following:

The cake is too soft if the solid material is doughy, does not crumble, slides down a roughly 45° inclined surface rather than tumbling.

When pressed together (“normal hand pressure”) significant amounts of liquid comes out.

The cake is too firm if the solid material crumbles into very small individual pieces, does not break up after emerging roughly 30 mm from the mouth piece, no water at all can be observed when pressing together (“very strong hand pressure”).

These descriptions offer only a rough classification, and conditions depend heavily on the specific medium. The actual limits must be determined individually in practice.

These guidelines serve only to assess a stable cake, not to determine the dry matter content of the solid phase.

7.3 CONFIGURATION TO STABILIZE THE SOLID CAKE

7.3.1 Cake Too Firm

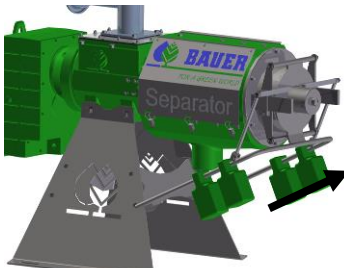

Fig. 7-4 Cake too firm

Move the weights inward on the arms or remove them entirely.

If the cake is too firm, the separator may clog up after prolonged operation since the cake can no longer be pushed out of the mouthpiece!

In order for the cake to be ejected more easily, the weights can be moved forward symmetrically. If this is not sufficient and the cake is still so firm that even the motor protection circuit breaker is tripped, the weights can also be removed entirely and the solid matter pressed in only by the dead weight of the lid.

If there is a risk of the cake hardening during downtime, either a new starter cake should be used for startup later, the weights on the lever arms should be reduced or the cake should be softened with water. Never attempt to restart the machine with a hard cake in manual mode via “jogging” since this can cause damage to the machine.

7.3.2 Cake Too Soft

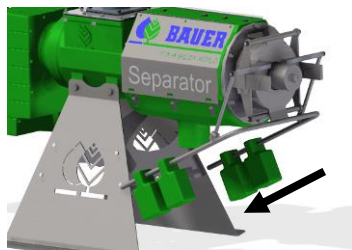

Fig. 7-5 Cake too soft

If the cake is too soft, this can result in the cake “shooting out”; in other words, the cake breaks up and unseparated medium flows out of the solid side!

In order to make the cake harder and more stable, symmetrically move the weights toward the back.

Depending on the medium, the adjustments described above must be performed multiple times upon startup until a stable condition is reached and the performance of the separator is optimized.

7.4 ADDITIONAL INSTRUCTIONS FOR FLAWLESS OPERATION

Make certain that the overflow does not produce a siphon effect.

This would produce unfavorable flows with too little solid matter entering the separator, lowering the throughput while also interfering with the self-cleaning of the screen, which is activated by the solid matter.

NOTE 	For this reason, ensure good ventilation of the overflow!
--	--

An excessively supply pump high delivery rate also causes unfavorable inflow conditions in the separator.

NOTE 	The feed rate should be reduced far enough that the entire cross-section of the overflow drainage pipe is not completely filled. As a guide value, strive for approx. $\frac{1}{3}$ to $\frac{1}{2}$ of the cross-section!
--	---

The outlet of the overflow pipe may not be submerged below the liquid level; otherwise, the inflow behavior into the separator will also be negatively affected by a siphon effect.

The overflow pipe must be free of bottlenecks and dimensionally stable since clogging or a collapse would cause the inflow pressure in the separator to become too high, forcing out the solid cake.

Make sure that the pumped medium (material to be separated) **is mixed well before separating** to avoid “shooting” or “clogging” due to irregularities. **But also ensure** that the slurry is not stirred up and repumped too often (especially for small pre-pools) causing the slurry consistence to change (become smooth) up to the point when no solid matter is separated at all. As a remedy, a buffer container should be situated at the separator inflow that is filled by means of a level control.

8 WINTER OPERATION

If temperatures are below freezing and the separator is not operated continuously or will be stopped for several days, take the following measures:

- Ensure that all hoses and the separator are completely emptied upon switching off the device to prevent freezing of the liquid.
- Switch off the pump.
- Remove the weights, the mouth piece, the auger and the screen and clean the components with a high-pressure cleaner before storing them in a protected location.
- If renewed separator operation is possible, reassemble it.

If the solid cake is not frozen completely through, it may be possible to start up the separator using the partially frozen cake. Start the machine carefully and watch the amperemeter to prevent overloading of the machine. It may be necessary to thaw the solid cake with hot water before the separator can be operated normally.

In order to ensure optimal operation in regions with prolonged cold periods, the separator should be installed in a shelter or room protected against freezing.

9 TEST FOR SEPARATION CAPABILITY

In order to test the separation capability of the medium supplied to the separator, you can perform a simple suitability test. Take some of the medium intended for separation into your hand and try to press it out. If the medium is a very fine-grained solid and seeps through your fingers during this test, it cannot be mechanically separated without reducing the viscosity.

However, if liquid escapes through your fingers and solid matter remains in your hand when opened, then this medium can be separated in the separator.

You can also perform this test with the effluent of the separator to determine whether further separation in the separator is possible by using screens with lower gap widths. For example, if the first separator is operated with a gap width of 0.75 mm, the effluent can be introduced to a separator with a gap width of 0.25 mm and so on.

To determine the possible dry matter content for your application using the separator, perform a screen test, such as with a screen of gap width 0.50 mm. The dry matter content when using the separator will always be higher than your test result since the solids are filtered by the solid cake, meaning that even solids with a size smaller than 0.50 mm will be captured in the cake.

If the demand for the separated medium is very high, such as when expanding operations, it is possible as well as effective to run multiple separators in parallel as shown in Fig. 9-1.

It should be noted here that, in this case, an elevated tank should be used in order to evenly supply the separators in parallel. Also ensure that the liquid pressure on the separator does not exceed a value of 2 m water column.

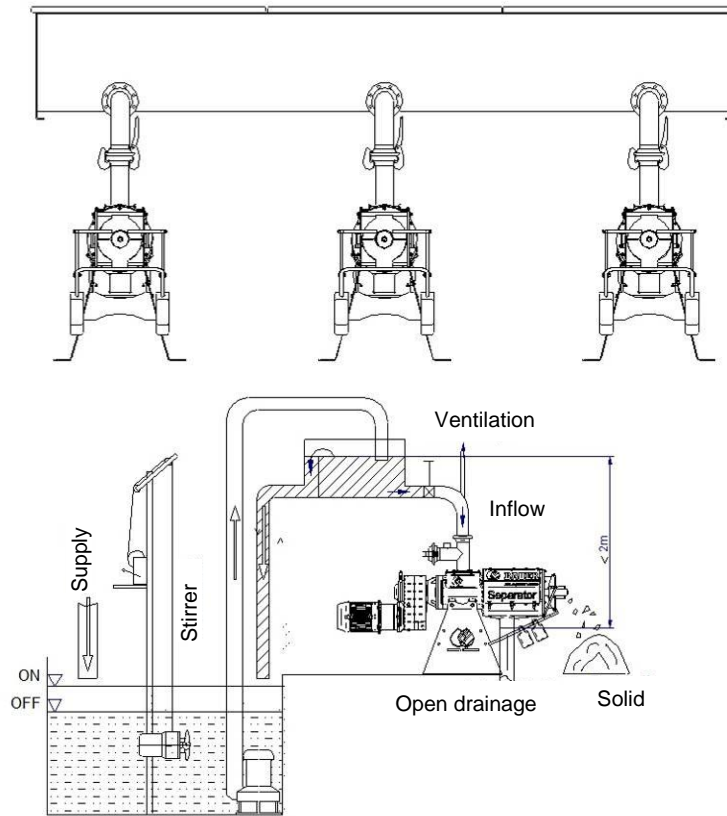

Fig. 9-1 Typical arrangement for the operation of 3 separators in parallel

10 LIQUID CLEANING

Fig. 10-1 illustrates the arrangement of 2 separators in series, where the effluent of the first separator is supplied to the second separator. The second separator is equipped with screens of a smaller gap width than the first separator in order to achieve a further clarifying of the liquid.

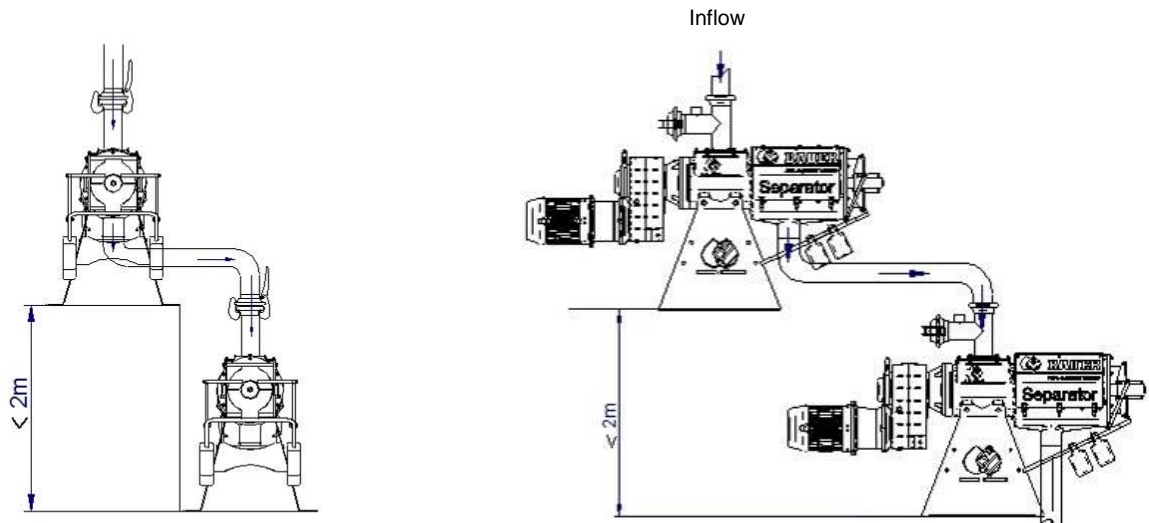

Fig. 10-1 Typical arrangement for the operation of 2 separators in series

11 IMPORTANT ASPECTS TO BE CONSIDERED DURING OPERATION

- Check the output of the pump to ensure that the overflow “bypass” is only half full.
- Inspect the pump to ensure that the operating pressure on the seal of the auger drive does not exceed 2 m water column.
- Make certain that no pipelines are pressed together and no negative pressure arises in the supply system.
- The higher the DM content in the input material, the better the separation will be if the input medium is homogenized. If the solid concentration of the input medium declines significantly, check the solid cake by returning some of the separated solid to the separation process.
- Under normal conditions, the arms of the output regulator “breathe” somewhat; in other words, they move up and down a little. If the up and down movement of the arms is too large, you must increase the contact pressure by increasing the number of the weights or their leverage. If the contact pressure becomes too high, the solid cake will become too hard [see section 14 “Problems - Troubleshooting”].

12 TAKING THE SEPARATOR OUT OF OPERATION

1. Switch off the feed pump to the separator.
2. Allow the separator to continue running for about 1 to 2 minutes until no more solid or separated slurry is discharged, then switch it off.
Depending on the type of medium being separated, the separator may sit unused for up to a week or more without the need to remove the solid cake.
3. For longer periods of disuse, the cake should be removed and the separator cleaned. To remove the cake, open the lid and break up the cake by hand.
4. If the separator is also used in freezing temperatures, it should be ensured after operation that all supply and return pipes as well as the separator itself are completely emptied in order to prevent freezing of the slurry. If the cake is frozen solid in the separator, it must be thawed with hot water before restarting.

13 MAINTENANCE AND INSPECTION

13.1 GEARBOX AND MOTOR

The gearbox and motor are delivered ready for operation. They are filled with the required volume of oil and **maintenance-free**. After approx. 10,000 operating hours, but no later than every 2 years, the oil must be changed and the bearing inspected; details on this work can be found in the gearbox and motor documentation.

Perform a daily visual inspection during operation to ensure that the seals of the gearbox and machine are tight.

Check the oil level of the gearbox roughly twice per year. Other than a regular supply of sealing medium, the Bauer separator normally requires little maintenance.

13.1.1 Supply with Sealing Medium

NOTE



It must be ensured that the used sealing media and greases are compatible with the seals (FPM material). Greases of viscosity class 2 are used as standard, such as Alvania EP 2 from Shell, Beacon EP 2 from Esso or Aralub HLP 2 from Aral.

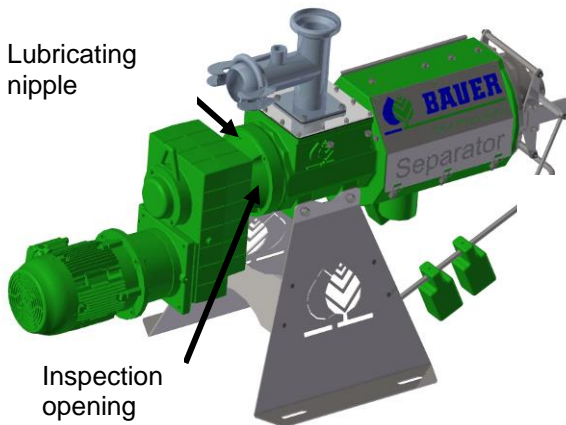

Fig. 13-1 Supply with sealing medium

On a separator in operation, it is important to supply sealing medium to the blocking seal in the attached unit against the inflow housing in order to protect the seals in the attached unit from the medium being separated. This can be accomplished with sealing grease.

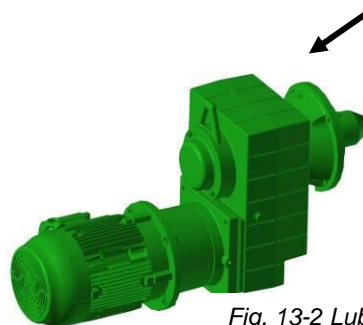

Fig. 13-2 Lubricating nipple

For this purpose, a grease press must be used **every 250 operating hours or every 2 weeks** to introduce roughly 3 to 5 cm³ of grease via the lubricating nipple.

The grease should be supplied while the machine is running to ensure that the entire seal area is filled with sealing medium. Lubricate the other lubricating nipples on the geared motor 1x per year.

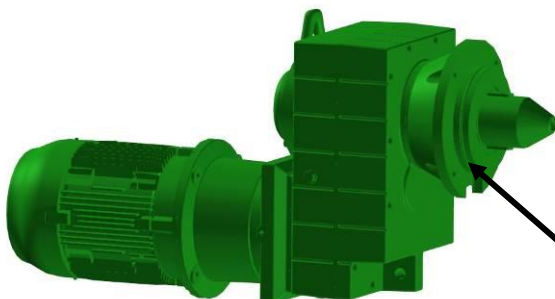

Fig. 13-3 Inspection opening

To safeguard the function of the seal, check the inspection opening on the bottom of the flange. If sealing medium, water or foreign substances escape here, the blocking seal is damaged or worn and must be replaced. If the blocking seal is not replaced, the supply medium can clog the inspection window over time and also damage the second seal, allowing the medium to damage the bearing and/or the gearbox. It is therefore very important to regularly check the inspection opening on the bottom of the flange. No medium should escape from this opening; otherwise, the blocking seal is damaged and must be replaced.

13.1.2 Supplemental Seal

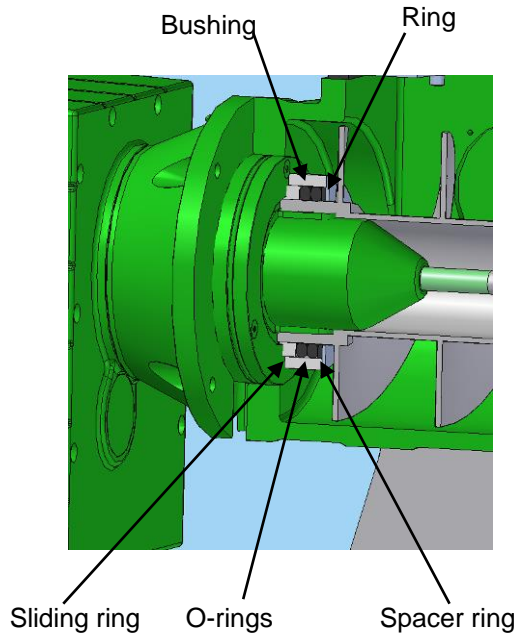

Fig. 13-4 Supplemental seal

The supplemental seal provides additional protection for the attached unit of the geared motor and forms one stage of the labyrinth seal

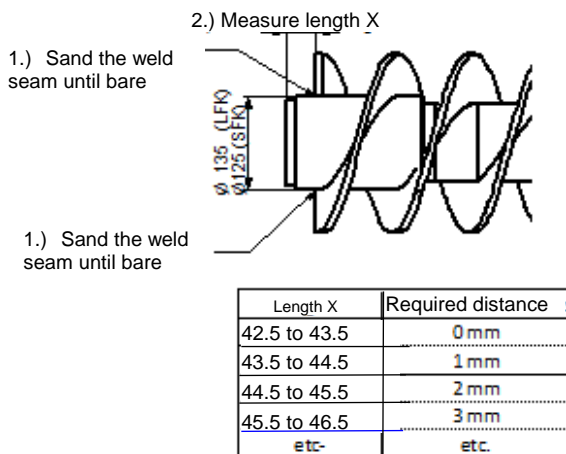

Fig. 13-5 Definition of the spacer ring

Subsequent installation of the supplemental seal:

1. Sand the weld seam until bare.

The diameter of the auger is 125 mm for SFK augers and 135 mm for LFK augers. Older augers may have a larger diameter than indicated above. If this is the case, the auger must be lathed down.

2. The length "X" determines the required spacer ring - see Fig. 13-5.

The following spacer rings are available:
1 mm, 2 mm and 3 mm.

If a distance of 3 mm is required, install the 1 mm + the 2 mm spacer ring.

13.2 INSPECTION OF THE SCREEN AND THE GUIDE RAILS

The screen and the guide rails must generally be inspected every 1 to 3 months depending on the separation medium.

For this inspection, the screen must be removed, cleaned with a high-pressure cleaner and then checked for damage and traces of wear. The plastic profiles of the guide rails visible in the housing must also be checked for an even contact pattern and good seating. Defective profiles can cause damage to the screen.

When the screen basket is replaced, the plastic profiles must also be replaced with new ones.

To remove the screen and auger, do as follows:

1. Switch off the feed pump or stop the supply flow.
2. Remove the weights from the output regulator; open the flaps of the output regulator.
3. Allow the separator to run until no more liquid or solid material emerges.
4. Switch off the separator and the main switch on the switch cabinet, then secure the main switch against reactivation (e.g. with a padlock).
5. Remove the bolt (internal brace) in the head of the auger. The length of the bolt is always the same as the length of the auger. Remove the mouthpiece by unscrewing the 6 nuts that hold it in place.
6. Loosen the lock nuts of the scraping bolts and turn the scraping bolts roughly one turn counter-clockwise, see Fig. 13-16.
7. Remove the rest of the solid cake. You can use a large screwdriver for this. If the cake is very hard, use a high-pressure cleaner to soften up the cake in order to pull out the auger and screen.
8. Pull out the screen, or, if it is difficult to separate the screen and auger because solid matter is jamming the screen and auger, wash out generously with water. This will loosen the screen.

WARNING!



Never pound on the screen or the auger to loosen them as these are precision components that must be handled with care.

The screen guide rails are situated inside the housing of the separator. A plastic profile rail (T-rail or G-rail) is inserted in the screen guide rails.

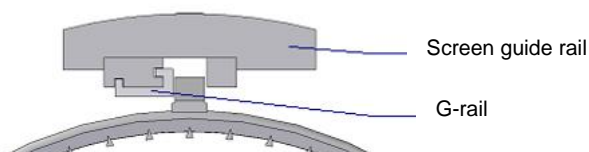

**- For installation of standard screens:
Insert G-rail plastic profile**

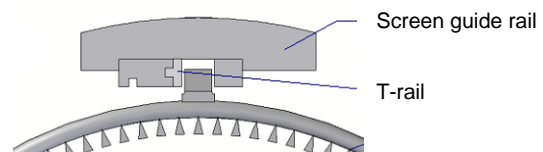

**- For installation of high-pressure screen:
Insert T-rail plastic profile**

Fig. 13-6 G-rail -- T-rail

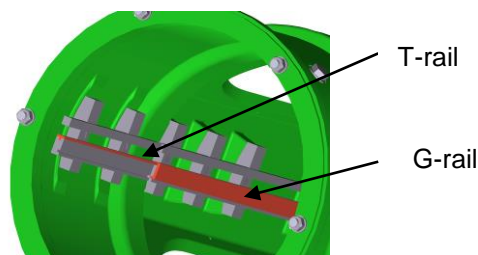

Fig. 13-7 Housing of Separator S855 with screen guide rails and G-rail plastic profile for standard screen in the drainage area and T-rail plastic profile for high-pressure screen in the press area

The plastic profile rails serve to dampen the impact shocks of the separator on the screen guide rails and reduce friction.

The screen “floats” [“breathes”] in the guide rails, depending on how hard the solid cake is. The slight up and down movement of the output regulator lever arms are an indication of the “floating” of the screen in the separator housing.

Inspect both the screen and the plastic profile rails inserted into the guide rails for any wear. If uneven wear is discernible on the plastic profile rails, these must be replaced with new ones. When inserting a new screen, the plastic profile rails must naturally also be replaced. Solid matter in the area of the guide rails must be washed out.

WARNING! 	Never loosen the fastening bolts of the screen guide rails on the housing as these are precision components that must be handled with care.
--	--



Fig. 13-8 Fastening bolts

The screen guide rails are aligned during assembly of the separator using a special template then fixed in place with the fastening bolts and should not be loosened again. However, if the setting is changed due to an error, they must be realigned. You can obtain the required alignment template along with instructions from your nearest BAUER dealer.

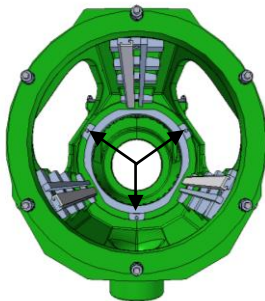

Fig. 13-9 Wear ring

Follow the instruction in sections 6 and 7 to restart the machine.

Also clean the area in which the wear ring sits. This is located at the rear of the housing at the transition to the inflow area and is affixed to the housing with 3 bolts. This ring protects the housing from wear as the screen “breathes” during operation. The wear ring should be replaced no later than after radial wear of approx. 1 mm

(when the inner diameter of the wear ring is approx. 263 mm) in order to prevent screen damage.



Fig. 13-10 Wear ring bolts

For this, remove the 3 bolts and nuts of the wear ring on the outside of the body. Pull the wear ring out of the screen housing and replace it with a new one.

13.3 INSPECTING AND REINSTALLING THE SCREEN

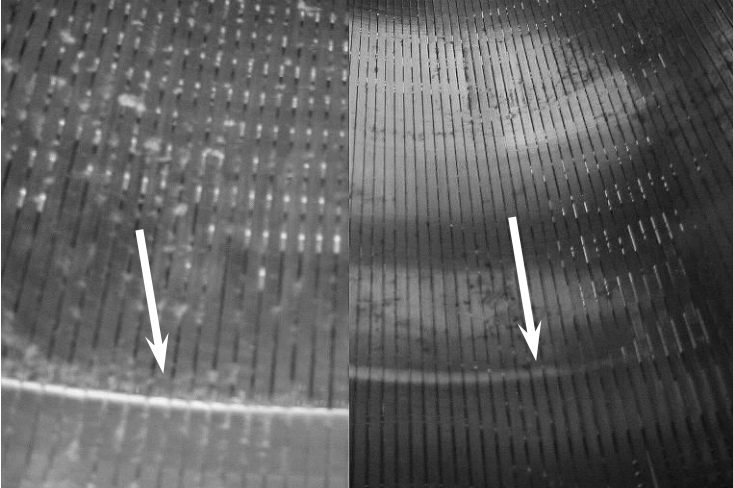

Fig. 13-11 Wear in the screen due to screen under tension (left) Normal screen wear (right)

The wearing of the screen occurs primarily in the area where the auger blades end in the screen, i.e. at the transition to the pressing area of the separator. If a sharp-edged transition can be seen in this area (Fig. 13-11 left), the screen was not installed again correctly after the previous inspection. In this case, the screen was damaged due to insufficient floating capacity.



Fig. 13-12 Screen installation position, stamped triangle at top and toward the front of the separator

When you reinstall the screen, make sure that the triangle stamped into the guide rod of the screen is “up” [12 o’clock position], see also Fig. 13-12. If this original installation position is retained, it is possible to identify the causes for any uneven wear on the basis of wear marks.

The screen must have sufficient floating capacity after reinstallation; in other words, it must not be under axial tension from the housing and the mouthpiece. If installed correctly, the screen can be moved somewhat by hand. A small gap of several tenths of a millimeter must exist between the mouthpiece and the screen. This must be checked with a thickness gage (Fig. 13-13).



Fig. 13-13 Movable screen in the separator, inspection of the floating capacity by hand (left)

Inspection of the floating capacity with the thickness gage

13.4 INSPECTING AND REINSTALLING THE AUGER

The auger is made of stainless steel. In the area of the screen, the auger blades have been plated with a special material according to a special process, see Fig. 13-14.

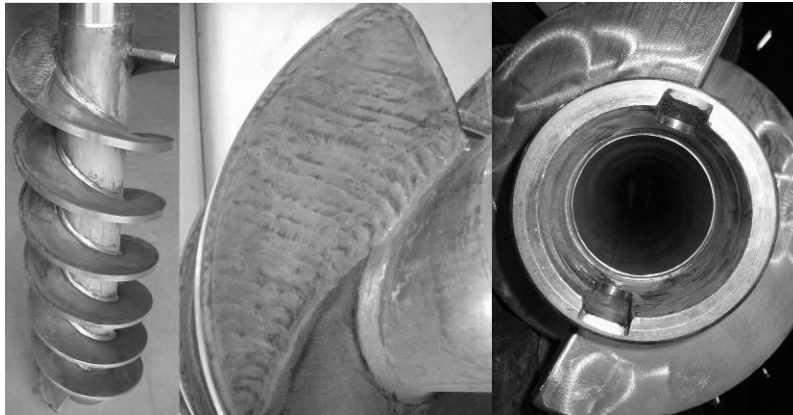

Fig. 13-14 Auger plated with special material and hub mount, new condition

Inspect the auger for any damage and clean it. The axial contact surface of the auger mount shown in Fig. 13-14 and the feather key grooves must be free of solid matter and must not exhibit any damage or markings; otherwise the auger will rotate out of true, thereby damaging the screen.

If both the auger and the screen are in good condition [see the following section for the criteria to evaluate the auger and the screen], the auger can be installed.

Insert the auger carefully into the separator **without** striking the feather keys against the axial contact surface of the auger. This could cause the auger to exhibit axial eccentricity. Turn the auger until the feather keys snap into the feather key grooves of the auger. Then press the auger upward and screw it with the auger bolt again (tightening torque 200 Nm).

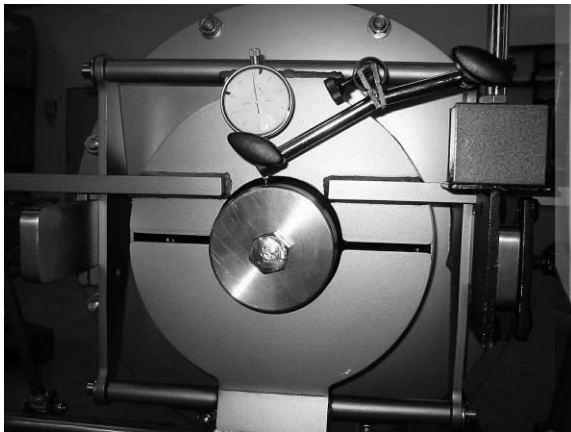

Fig. 13-15 Inspection of the auger axial eccentricity

Check the auger again for axial eccentricity. This should be less than 1 mm, otherwise the screen will be damaged. Fig. 13-15 shows the axial eccentricity check at the factory. If the axial eccentricity is larger, inspect the auger and fastening elements again for damage, marks and soiling.

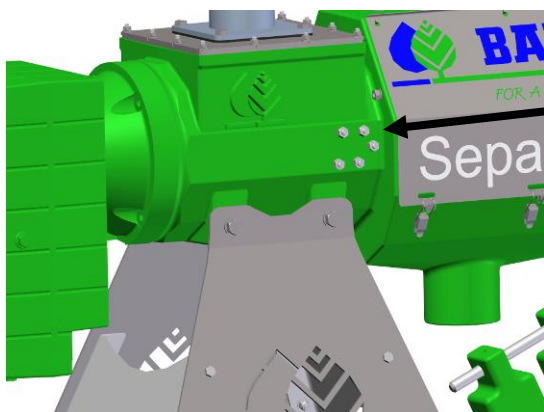

Fig. 13-16 Scraping bolts

Then readjust the scraping bolts. To do this, loosen the lock nuts and slowly adjust the scraping bolts while turning the auger until the bolts scrape against the auger. Then turn the bolts back approx. 30° and lock the lock nuts. The scraping bolts must be readjusted every 4 weeks.

13.5 EVALUATION CRITERIA FOR THE AUGER AND SCREEN WITH REGARD TO WEAR AND RECOATING

All moving parts on the separator are subject to some amount of wear. Some of the parts that are directly subject to wear and must therefore be inspected regularly have already been described. Good regular inspections and maintenance of the wearing parts will significantly lengthen the service life of the parts. Worn parts should be replaced as quickly as possible in order to avoid the damage that might otherwise result.

The parts that directly influence the operation of the separator are the screen and the auger. Independent of this, the "normal" operating condition of the separator is also influenced by parameters other than wear.

In principle, only the auger can be recoated to be used again; the screen cannot be recoated.

In order to ensure the necessary quality and precision, the recoating of the auger may only be performed by a workshop authorized by BAUER GmbH.

WARNING



Never hire another shop to recoat the auger for you since incorrect performance and failure to observe the necessary tolerances could destroy the screen and void all warranty claims. (See Fig. 13-11 Screen wear)

The normal wear of the screen can be observed as an increase in the inner diameter and the screen gap width. The wear of the screen and the auger generally affects the proper functioning of the separator and can be identified based on reduced throughput and worse drainage of the liquid phase. However, when observing such changes, it must also be ruled out that the supply medium and its consistency have changed.



Wearing of the screen or of the auger on the outer edges of the blade changes the working gap. In new condition, the working gap and therefore the radial gap between the screen and the auger (initial gap width) is approx. 0.2 - 0.4 mm; this can be measured with a thickness gage (Fig. 13-17). If the radial gap between the screen and the auger becomes twice the initial gap width or larger, this influences not only the operating condition but also poses the risk that the screen could be damaged or even split. If the radial gap between the screen and the auger is still larger than two times the original gap width even after replacing the screen, the auger must be recoated.

Fig. 13-17 Measuring of the working gap between the screen and the auger; the gap is measured on the bottom side of the screen while the machine is at rest. The measurement yields two times the working width because the screen rests on the top of the auger when the machine is not running.

The most important criterion for the wear of the screen and the auger is however the operating condition of the machine; in other words, if the result no longer satisfies the requirements (throughput, liquid phase, etc.), the screen must be replaced and/or the auger recoated.

Additional indications for the need to recoat the auger can be found in the appearance of the plating material as shown below in Fig. 13-18.

In principle, the auger should be recoated before the plating has been removed by wear, uncovering the base material of the auger. Otherwise, the wear on the auger will increase severely enough that it can no longer be recoated at reasonable expense.

For example, Fig. 13-18, right and middle images, shows plating that has been worn down on the outer edges of the auger, but recoating is still possible because the plating on the face side is still retained up to 20%, meaning that the actual auger blade has not yet been damaged. Excluding the plating, the auger blades have a thickness in this area of 10 mm, meaning that the remaining plating can be determined very precisely with a depth caliper.

The left image in Fig. 13-18 shows a auger on which the axial plating has been worn down completely on the outer edges of the auger blade. In addition, the auger thickness itself has been reduced almost to half. A cost-effective recoating is not possible in this case since the base stiffness of the auger blade would no longer suffice for sufficient bonding of the plating. A new auger is therefore required.

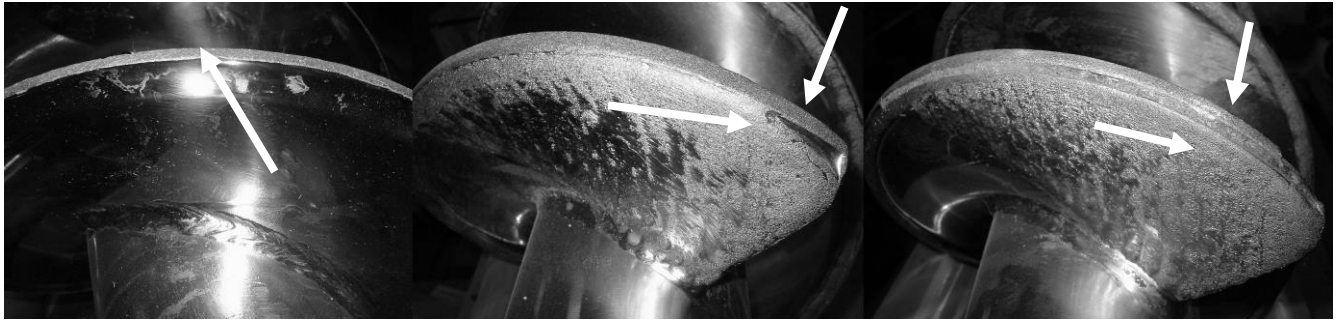



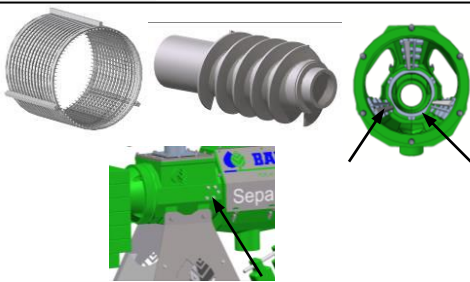



Fig. 13-18 Indications of the need for recoating the auger

13.6 SUMMARY OF MAINTENANCE AND INSPECTION INTERVALS

 WARNING	Check the operational safety of the machine before every start !	
<p><u>Daily:</u></p> <ul style="list-style-type: none"> • Visual inspection of the solid cake and the effluent • Visual inspection of the machine and gearbox seals (see section 13.1.1 Fig. 13-3 Gearbox inspection opening) 		
<p><u>Every 250 operating hours (or every 2 weeks):</u></p> <ul style="list-style-type: none"> • Supply with sealing medium (see section 13.1.1) 		
<p><u>Every 1-3 months (depending on the separation medium)</u></p> <ul style="list-style-type: none"> • Inspection and cleaning of the housing, screen, guide rails, plastic profile rails, auger, housing protection ring (see sections 13.2- 13.5) • Readjust scraping bolts (see section 13.3 Fig. 13-13) 		
<p><u>Every 6 months:</u></p> <ul style="list-style-type: none"> • Check gearbox oil level 		
<p><u>After 10,000 operating hours (no later than every 2 years)</u></p> <ul style="list-style-type: none"> • Geared motor oil change (see the gearbox and motor documentation for oil quantity and type) • Inspect the bearing (see the gearbox and motor documentation for details) 		

14 PROBLEMS - TROUBLESHOOTING

WARNING

Troubleshooting should only be performed by appropriately qualified personnel.

It is very important for you to familiarize yourself with the “normal” operating condition of the separator during your application. “Normal” includes the discharge speed in direct connection with the desired DM content of the solid cake. The DM content can be adjusted via the position and number of weights on the lever arm of the output regulator. You will need to incrementally vary the settings to determine the optimal and for you “normal” operating condition. It is also necessary to adjust the pump throughput in order to determine the optimal capacity utilization of the separator for the “normal” condition. The effluent discharge and throughput represents another factor that can be evaluated.

However, since the consistency of the supply medium can change over time, you must expect that the “normal” operating condition of the machine in your application will also change.

If major changes with respect to the “normal” operating condition occur over a prolonged period of time, it is important to determine the precise cause. The search for possible sources of error is simpler when the principle and functioning of the BAUER separator are sufficiently well understood.

14.1 PRINCIPLES OF A “NORMAL” OPERATING CONDITION

The auger of the separator has a defined diameter over its length and is adapted to the screen cylinder. The auger and screen diameters are very precisely adapted to each other, and this relationship must be maintained to ensure optimal operation of the separator.

The open drainage of the influent takes place in the inflow area of the screen; in other words, the water not bound up in solid matter via capillary action is removed. In the press area, where the solid cake forms, water bound up via capillary action is pressed out. If the influent contains no solid matter, no solid cake is formed as well as no transport or continuous discharging of the cake. In principle: the higher and more uniform the incoming concentration of solid matter, the larger the discharge speed of the solid cake from the mouth piece.

The uniformity of the influent directly determines the discharge speed of the solid cake. To achieve sufficient homogenization and uniformity of the solid matter in the liquid, it is necessary to use a stirrer that is adapted to the throughput and situated in the inflow tank before supply of the medium to the separator. The use of a bypass or overflow line at the T-piece of the separator inflow helps ensure that the separator only receives the optimal volume of medium for the process without producing excess pressure in the separator. The solid cake formed in the separator produces a self-cleaning process for the screen, thereby ensuring optimal operation of the separator.

This self-cleaning effect of the screen is significantly influenced by the working gap between the screen and the auger. Wear on the screen or on the outer edges of the auger blade can change this working gap and negatively impact the self-cleaning process as well as the “normal” operation of the separator.

Indications of possible deviations from the “normal operating condition” of the separator as well as possible causes and remedies are provided in the following table to assist you in troubleshooting problems.

14.2 TROUBLESHOOTING

Fault	Cause	Remedy
<p>No solids are produced</p> <p>No liquid is discharged</p> <p>Separator is running</p>	<ol style="list-style-type: none"> The material supply has been interrupted: <ul style="list-style-type: none"> The pump is off T-piece at the inflow or ventilation opening blocked; a siphon effect occurs [“overflow line is completely filled”]; the outlet of the overflow line is submersed in the liquid. Clogged / restricted effluent line The auger is turning clockwise. The rotation direction of the pump is incorrect, the supply line is vibrating Long fibers (hay, stray, etc.) are blocking the liquid transport 	<ol style="list-style-type: none"> Check: Switch cabinet and overflow line. <ul style="list-style-type: none"> Inspect and start the pump. Clean the lines. Install a ventilation pipe with a larger cross-section; reduce the pump capacity; ensure that the overflow line is clear. Ensure that the liquid can drain freely. Swap the two phases of the electricity line so that the auger <u>turns counterclockwise</u>. Change the rotation direction of the pump. Replace the cutting blade in the pump cutting unit.
<p>Solid discharge too low</p> <p>Effluent discharge too low (lower than is typical for this medium)</p> <p>Separator is running</p>	<ol style="list-style-type: none"> Pump capacity (feed rate) is too low – no overflow in the bypass line Lifting effect in the overflow line, the medium is being drawn out of the separator Too many weights in place or too much contact pressure Excess wear on the screen or auger Screen positioned incorrectly or clogged; Auger channels clogged Screen only worn in certain places, guide rails for the screen not set correctly Slurry is pumped / stirred too much (ground fine) 	<ol style="list-style-type: none"> Inspect pump (rotation direction) and/or control the pump capacity. Check the transport line. Affix the ventilation valve / pipe to the T-piece of the separator. Reduce the feed rate so that the overflow pipe is no more than half full. Ensure that the overflow can flow out freely. Remove two weights or reduce the leverage of the weights. Check the auger diameter, check the screen for wear. Replace the screen and auger, if necessary. Clean the screen through the side windows or remove it for cleaning, if necessary. Activate the reverse direction control. Clean the auger, contact the BAUER company concerning possible changes to the inflow of the separator. Check the guide rails for soiling / clogging Install a buffer container at the inflow.
<p>Solid discharge is very low</p> <p>Effluent discharge is normal</p> <p>Separator is running</p>	<ol style="list-style-type: none"> The solid portion in the inflow is very low The gap width of the screen is too large 	<ol style="list-style-type: none"> Add some solid to the inflow. Install a screen with a smaller gap width. The available screen gap widths are: 0.1, 0.25, 0.35, 0.50, 0.75, and 1.25 mm. After changing the gap width, accustom yourself to a change in the “normal” operating condition.

Fault	Cause	Remedy
<p>Solid cake is very hard; Solid matter comes out slowly and very dry</p> <p>Separator is running The amperemeter indicates higher values than usual</p>	<ol style="list-style-type: none"> 1. Too many weights or the leverage is too great, meaning that the contact pressure of the output regulator is too high. 2. The supply medium has changed or the supply line has been changed. 	<ol style="list-style-type: none"> 1. Reduce the number of weights or the leverage; if the contact force is too high, the screen could be destroyed. 2. Check the consistency of the supply medium and check the supply line for any blockages.
<p>No discharging of solids Minimal discharging of liquid</p>	<ol style="list-style-type: none"> 1. Rotation direction of the separator reversed 2. Auger channels clogged 	<ol style="list-style-type: none"> 1. Check the electrical connection. 2. Check and clean the auger.
<p>Increased auger and screen wear</p>	<p>Abrasive components in the medium, such as sand</p>	<p>If possible, allow the abrasive components to settle before separation.</p>
<p>Moisture content of the discharged solid varies greatly</p>	<p>The separated medium (slurry) has varying consistency</p>	<p>Mix and homogenize the medium (slurry) thoroughly.</p>
<p>Geared motor of the separator switches off</p> <p>The motor switches off when the permissible power consumption of the motor has been exceeded. The setting for the maximum power consumption applies to operation under load</p>	<ol style="list-style-type: none"> 1. Overload 2. Power consumption is too high because the solid cake is too hard. 3. The setting for the maximum power consumption is not configured correctly or the control unit has been damaged. 4. Foreign bodies are blocking the auger 	<ol style="list-style-type: none"> 1. Check the motor protection for correct setting; set to maximum value, if necessary. 2. See configuration instructions in the section Initial Startup. 3. Have the shut-off limit adjusted again by a qualified electrician according to the instructions in the switch cabinet circuit diagram. 4. Check the inflow to the separator and remove any foreign bodies; check the auger and screen.
<p>Cake ejection – The cake has been pushed out</p> <p>The solid cake breaks up and liquid emerges from the mouth-piece</p>	<ol style="list-style-type: none"> 1. Not enough weights or the leverage of the weights is too low. 2. The pump pressure is too high; the optimal pressure / operation for the separator is 2 m water column with a steady feed rate. 3. The incoming concentration of solids fluctuates greatly. The separated medium has too little solid content 4. Solids are too fine and have no fibrous structure 	<ol style="list-style-type: none"> 1. Add additional weights or increase the leverage of the weights (important: never more than two weights per lever arm). 2. Reduce the pump pressure by lowering the pump capacity or replacing the pump. 3. Thoroughly mix and homogenize the medium (slurry) to produce a uniform solid cake speed. See configuration instructions in the section Initial Startup. The cake may be ejected if the solid content in the supply medium decreases significantly. 4. Use a finer screen.

Fault	Cause	Remedy
<p>Replacement of the blocking seal</p> <p>Despite the supply of sealing medium (see section Maintenance and Inspection under Supply with Sealing Medium), liquid and sealing medium is discharged from the inspection opening on the bottom of the flange.</p>	<ol style="list-style-type: none"> 1. The pump is a high-pressure pump and/or the supply medium is highly abrading. 2. The blocking seal has been worn out by the duration of operation. 	<ol style="list-style-type: none"> 1. Replace the pump with a low-pressure pump. 2. The blocking seal must be replaced before the second seal is damaged, which would lead to damage to the bearing or the geared motor.
<p>Problems that cannot be corrected</p> <p>A problem as described above cannot be corrected despite optimal configuration according to the instructions given above.</p>	<p>Document the symptoms and the measures you have taken to correct the problem.</p>	<p>Contact your dealer or the BAUER company.</p>

15 ACCESSORIES

15.1 SEPARATOR CONTROL

DANGER 	<p>The connection of the switch cabinet to the electrical supply and the connection of the separator motor to the switch cabinet must be performed by an electrical expert. The cable dimensions and the preliminary fuse must correspond to the power specifications.</p>
--	--

The BAUER separator is generally delivered with an electrical switch cabinet that was designed for precisely your application (option).

Normally, the switch cabinet has additional connections, e.g. for the feed pump, the fill level sensor, etc., which are controlled by the switch cabinet or which control the operation of the separator. The circuit diagrams contained in the switch cabinet explain the individual electrical connections, the cabling and the circuits. Your electrician requires these circuit diagrams to connect the separator to the switch cabinet and your local power supply.

Every part and every component in the switch cabinet is numbered and listed in the parts list for the switch cabinet, which is appended to the circuit diagrams in the switch cabinet. Additional information required for ordering replacement parts, such as the manufacturer, can be determined based on these article numbers.

WARNING 	<p>The correct installation of the switch cabinet is absolutely essential for faultless operation. It is also absolutely essential that the operating personnel are familiar with the various settings on the switch cabinet.</p>
--	---



Fig. 15-1 Switch cabinet

The rotation direction of the separator auger can be switched between forward and reverse using the control.

Purpose:

For critical media (slurries), the screen can sometimes clog up over time, which impairs the function of the separator. In other words, the separator no longer removes water properly and the solid discharge also decreases as a result.

Turning the auger slowly backward (the auger turns opposite the feed direction) **cleans the screen**; the screen is cleared again, allowing the liquid phase to pass more easily through the screen gaps.

The times for forward and backward running of the auger can be individually set with the control. The required switching times vary for different media and can be individually adjusted.

In practice, the following time intervals have proved effective:

Forward	10 hours
Reverse	10 seconds

K7, K8: Switchover time between forward and reverse running

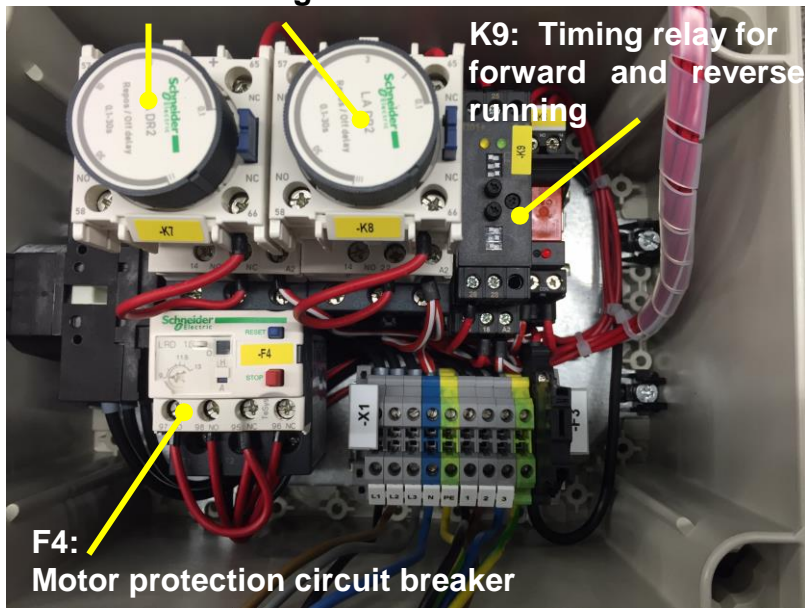

Fig. 15-2 Control

15.1.1 Timing Relay for Forward and Reverse Running K9

Each switching time setting is configured with **3 DIP switches** and a **control dial**.
 (By adjusting the DIP switches, the switching times can be interpreted as intervals of seconds, minutes or hours – as base value)

Factory setting: See the figures below

reverse (top)

switching time= 10 seconds

switch position

DIP switch:

left
right
right



Control dial:1,0

forward (bottom)

switching time= 10 hours

switch position

DIP switch:

left
right
left



Control dial:1,0



Abb. 15-3 timing relay



Control dial
arrow-position
Signal first

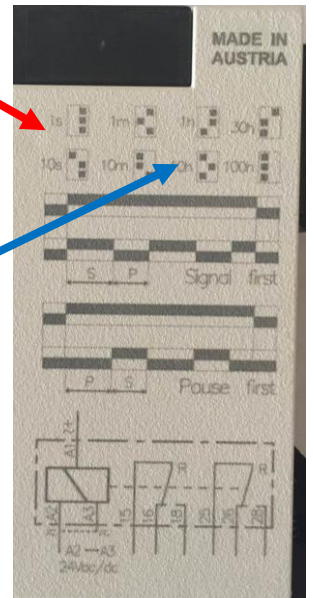

- The required switching times vary for different media and can be individually adjusted.

<p>WARNING</p> 	<p>before initial startup - ensure the correct rotation direction of the auger shaft when making the electrical connection! In forward motion, the auger shaft turns counterclockwise (as viewed from the output regulator toward the geared motor). If this is not the case, two of the current-carrying conductors at the geared motor connection or in the switch cabinet must be swapped.</p>
---	--

Additional configuration options:

These settings generally do not need to be changed!

15.1.2 Motor protection circuit breaker F4



Factory setting: 10A

WARNING 	Never set a value higher than 12A
---	--

Fig. 15-4 Motor protection circuit breaker

15.1.3 Switchover time (pause between forward and reverse running) K7, K8



Fig. 15-5 Switchover time

Factory setting: Pause upon switching over = 1 to 3 seconds

WARNING 	The motor takes time to stop! Never set this to a value less than 1 second.
---	---

16 FILL LEVEL SENSOR

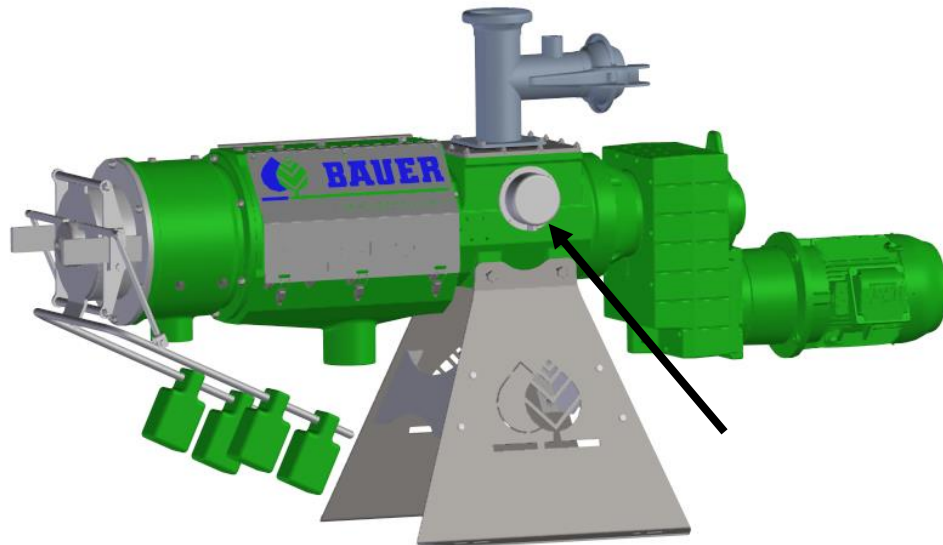

Fig. 16-1 Fill level sensor

The BAUER separator can be optionally equipped with a mechanical fill level sensor. The standard separator housing is designed with a cut-out for this in the inflow area. The cut-out is typically closed with a dummy cover.

The fill level sensor prevents dry running of the separator by switching off the geared motor if the medium in the separator falls below a specific volume. (The functioning of the supply pump to the separator is monitored; the separator is switched off if the pump fails.) It should be ensured that the separator does not run for too long without medium in order to avoid damage to the screen and auger.

Functioning:

The weight of the medium presses against the membrane of the fill level sensor. A tappet transmits the pressure from the membrane to the switch. If the medium level falls, the pressure on the membrane is relieved and the switch is switched back.

The fill level sensor is connected in the switch cabinet and switches off the geared motor when the medium in the separator falls below a certain volume.



17 NOTES

18 CONFORMITY DECLARATION

EC Conformity Declaration

according to EC Directive 2006/42/EC

The manufacturer

Röhren- und Pumpenwerk BAUER Gesellschaft m.b.H.
Kowaldstraße 2, 8570 Voitsberg, Austria
Tel: +43 3142 200-0; Fax: +43 3142 200-320/-340

declares that the machine named below

Machine designation	Bauer Separator
Machine type / base device	S655, S855, GB855

correspondingly applies to the relevant provisions of the following directives.

Machinery Directive	2006/42/EC
Electromagnetic Compatibility Directive	2014/30/EU
Low Voltage Directive	2014/35/EU

The following standards in the current versions were applied correspondingly:

EN ISO 12100:2011/03	Safety of machinery -General principles for design risk assessment and risk reduction
EN ISO 13857:2008/08	Safety of machinery – Safety distances to prevent hazard zones being reached by upper and lower limbs
EN 349:2008/09	Safety of machinery - Minimum gaps to avoid crushing of parts of the human body

This declaration becomes void in event of any changes to the machine made without the approval of Bauer GmbH.

Party responsible for documentation: Thomas Theissl, Kowaldstraße 2, 8570 Voitsberg, Austria